

**MX15 Series
AC and DC Power Source
User Manual**

TEL: +1 (858) 677-9040

FAX: +1 (858) 677-0940

Email: sales@calinst.com

Web Site: <http://www.calinst.com>

User's Manual
AC Power Source
California Instruments

Models:

- MX15-1
- MX15-1P
- MX15-1Pi
- MX30/2-1
- MX45/3-1
- MX30/2-1Pi (-MB)
- MX45/3-1Pi (-MB)

© Copyright 2006 - 2007, California Instruments. Rev D, April 2007.

SAFETY SUMMARY

This power source contains high voltage and current circuits, which are potentially lethal. Because of its size and weight, mechanical stability must be ensured. The following safety guidelines must be followed when operating or servicing this equipment. These guidelines are not a substitute for vigilance and common sense. California Instruments assumes no liability for the customer's failure to comply with these requirements. If the power source is used in a manner not specified by California Instruments, the protection provided by the equipment may be impaired.

BEFORE APPLYING POWER

1. Verify the correct three phase input voltage is applied to the unit. Input ratings are shown on the model and serial number tag located at the rear of the unit.
2. The chassis and cabinet of this power source must be grounded to minimize shock hazard. A chassis ground is provided at the input terminal block. This is located in the back of the cabinet on the lower right hand side below the inrush resistors. The rear cover panel must be removed to access the line input and ground connections. The chassis ground must be connected to an electrical ground through an insulated wire of sufficient gauge.

FUSES

Use only fuses of the specified current, voltage, and protection speed (slow blow, normal blow, fast blow) rating. Do not short out the fuse holder or use a repaired fuse.

DO NOT OPERATE IN A VOLATILE ATMOSPHERE

Do not operate the power source in the presence of flammable gases or fumes.

DO NOT TOUCH ENERGIZED CIRCUITS

Disconnect the power cable before servicing this equipment. Even with the power cable disconnected, high voltage can still exist on some circuits. Discharge these voltages before servicing. Only qualified service personnel may remove covers, replace components or make adjustments.

DO NOT SERVICE ALONE

Do not remove covers, replace components, or make adjustments unless another person, who can administer first aid, is present.

DO NOT EXCEED INPUT RATINGS

Do not exceed the rated input voltage or frequency. Additional hazards may be introduced because of component failure or improper operation.

DO NOT MODIFY INSTRUMENT OR SUBSTITUTE PARTS

Do not modify this instrument or substitute any parts. Additional hazards may be introduced because of component failure or improper operation.

MOVING THE POWER SOURCE

When moving the power source, observe the following:

1. Remove all AC power to unit.
2. Do not attempt to lift by hand. Unlock the casters and push the unit using two people to prevent injury or use forklift equipment with a qualified operator.

ALLOW CAPACITORS TO DISCHARGE

Capacitors in the power source may hold a hazardous electrical charge even if the power source has been disconnected from the mains supply. Allow capacitors to discharge to a safe voltage before servicing internal circuits or touching exposed pins of mains supply connectors.

SAFETY SYMBOLS:



THIS SYMBOL INDICATES DIRECT CURRENT



THIS SYMBOL INDICATES ALTERNATING CURRENT



THIS SYMBOL INDICATES BOTH DIRECT AND ALTERNATING CURRENT



THIS SYMBOL INDICATES THREE-PHASE ALTERNATING CURRENT



THIS SYMBOL INDICATES EARTH (GROUND) TERMINAL



THIS SYMBOL INDICATES PROTECTIVE CONDUCTOR TERMINAL



THIS SYMBOL INDICATES FRAME OR CHASSIS TERMINAL



THIS SYMBOL INDICATES ON (SUPPLY)



THIS SYMBOL INDICATES OFF (SUPPLY)



THIS SYMBOL INDICATES CAUTION, RISK OF ELECTRIC SHOCK



THIS SYMBOL INDICATES CAUTION (REFER TO ACCOMPANYING DOCUMENTS)

WARRANTY INFORMATION

CALIFORNIA INSTRUMENTS CORPORATION warrants each instrument manufactured by them to be free from defects in material and workmanship for a period of one year from the date of shipment to the original purchaser. Excepted from this warranty are fuses and batteries that carry the warranty of their original manufacturer where applicable. CALIFORNIA INSTRUMENTS will service, replace, or adjust any defective part or parts, free of charge, when the instrument is returned freight prepaid, and when examination reveals that the fault has not occurred because of misuse, abnormal conditions of operation, user modification, or attempted user repair. Equipment repaired beyond the effective date of warranty or when abnormal usage has occurred will be charged at applicable rates. CALIFORNIA INSTRUMENTS will submit an estimate for such charges before commencing repair, if so requested.

VOIDED WARRANTY

Any misuse or abuse of, as well as any modifications or changes made to any California Instruments product will automatically void the factory warranty. Removing non-normal use related covers or any sealed covers or lids also automatically voids factory warranty unless express written or email authorization is obtained from the customer service department in advance. The customer service department can be reached via email at support@calinst.com.

SERVICE PROCEDURE

If a fault develops, notify CALIFORNIA INSTRUMENTS at support@calinst.com or its local representative, giving full details of the difficulty, including the model number and serial number. On receipt of this information, service information or a Return Material Authorization (RMA) number will be given. Add the RMA number furnished to the shipping label. Pack the instrument carefully to prevent transportation damage, affix label to shipping container, and ship freight prepaid to the factory. CALIFORNIA INSTRUMENTS shall not be responsible for repair of damage due to improper handling or packing. Instruments returned without RMA No. or freight collect may be refused at California Instruments discretion. Instruments repaired under Warranty will be returned either via prepaid surface freight or low cost airfreight at California Instruments discretion. Instruments repaired outside the Warranty period will be returned freight collect, Ex Works CALIFORNIA INSTRUMENTS 9689 Towne Centre Drive, San Diego, CA 92121-1964. If requested, an estimate of repair charges will be made before work begins on repairs not covered by the Warranty.

DAMAGE IN TRANSIT

The instrument should be tested when it is received. If it fails to operate properly, or is damaged in any way, a claim should be filed immediately with the carrier. The claim agent should obtain a full report of the damage, and a copy of this report should be forwarded to us by fax or email (Fax: 858 677 0940, Email: support@calinst.com). CALIFORNIA INSTRUMENTS will prepare an estimate of repair cost and repair the instrument when authorized by the claim agent. Please include model number and serial number when referring to the instrument.

SPARE PARTS

To order spare parts, user manuals, or determine the correct replacement part for your California Instruments products, please contact the Customer Service department by phone at + 1 858 677 9040, press 2 or by email support@calinst.com.

Table of Contents

1	Introduction	10
1.1	General Description.....	10
1.2	Manual organization and format	10
2	Specifications	11
2.1	Electrical.....	11
2.2	Mechanical	19
2.3	Environmental	20
2.4	Regulatory.....	20
2.5	Front Panel Controls	20
2.6	Special Features and Options	21
2.7	Supplemental Specifications	28
3	Unpacking and Installation	33
3.1	Unpacking	33
3.2	Power Requirements	33
3.3	Mechanical Installation	34
3.4	AC Input Connections and Wiring	34
3.5	AC On/Off Circuit Breaker on MX Series front panel.....	38
3.6	Output Connections.....	40
3.7	Connectors - Rear Panel.....	48
3.8	Multiple Cabinet System Configurations (incl. –MB).....	55
3.9	Multiple Cabinet Power Up/Down Procedures.....	56
3.10	Clock and Lock Configurations.....	57
3.11	Basic Initial Functional Test.....	60
3.12	Remote Inhibit / Remote Shutdown.....	62
3.13	Junction Box Accessory	63
3.14	Output Filter Box Accessory.....	64
4	Front Panel Operation	65
4.1	Tour of the Front Panel	65
4.2	Menu Structure.....	70
4.3	Output Programming	95
4.4	Waveform Management [1Pi Controller only]	97
4.5	Standard Measurements	101
4.6	Advanced Measurements [1Pi Controller only].....	103
4.7	Transient Programming.....	104
5	Principle of Operation	110
5.1	General	110
5.2	Overall Description.....	110
5.3	Controller Assembly	112
5.4	System Interface Board.....	115
5.5	Current / Voltage Sensor Board	115
5.6	Low Voltage Power Supply.....	115
5.7	Power Module	116
6	Calibration.....	121
6.1	Recommended Calibration Equipment.....	121
6.2	Front Panel Calibration Screens.....	122
6.3	Routine Measurement Calibration	123
6.4	Routine Output Calibration	125
6.5	Non-Routine Calibration	126

7	Service	129
7.1	Cleaning	129
7.2	General	129
7.3	Basic operation	129
7.4	Advanced Troubleshooting	131
7.5	Factory Assistance	133
7.6	Fuses	134
7.7	Firmware Updates	134
8	Top Assembly Replaceable Parts	137
9	Options	140
9.1	Introduction	140
9.2	Option -HV: Additional AC Voltage Range	140
9.3	Option -160: RTCA/DO-160 Tests	141
9.4	Option -704: MilStd704 Tests	155
9.5	Option -ABD: Airbus ABD0100.1.8 Test	168
9.6	Option -787: Boeing B787-0147 Test	168
9.7	Option -WHM: Watt Hour Measurement	169
10	Error Messages	170
	Index	175

List of Figures

Figure 2-1: MX15-1 Voltage / Current Rating Chart for 150/300 V AC Ranges – Max Rating.....	14
Figure 2-2: Voltage / Current Rating Chart for 150/300 V AC Ranges – Derated.....	14
Figure 2-3: MX15-1 Voltage / Current Rating Chart for 200/400 V DC Ranges – Max. Rating	15
Figure 2-5: MX15-1 Voltage / Current Rating Chart, -HV Option – Max. Rating.....	24
Figure 2-6: Voltage / Current Rating Chart, -HV Option – Derated.....	24
Figure 2-7: -HF Option Voltage Frequency Rating 300V range.....	26
Figure 2-8: -HF Option Voltage Frequency Rating 150V range.....	26
Figure 2-9: MX output filter option schematic	30
Figure 2-10: MX45 Output Noise 10 KHz – 1 MHz.....	31
Figure 2-11: MX45 Output Noise 10 KHz - 1 MHz with optional Filter.....	32
Figure 3-1: The MX15 Power Source.....	33
Figure 3-2: Location of AC Input Fuse Block and Chassis Ground Connection - Rear View, Access Panel Removed	35
Figure 3-3: MX Series AC Input Connection Diagram (Rear view).....	37
Figure 3-4: Rear Panel.....	39
Figure 3-5: External sense cable shield connection to chassis ground	40
Figure 3-6: MX15-1 Output Wiring (Rear view).....	42
Figure 3-7: MX30/2 or MX30/2-MB Output Wiring (Rear view).....	43
Figure 3-8: Two MX's in Clock and Lock mode Output Wiring (Rear view)	44
Figure 3-9: MX45/3 or MX45/3-MB Output Wiring (Rear view).....	45
Figure 3-10: Three MX's in Clock and Lock mode - Output Wiring (Rear view)	46
Figure 3-11: Ship kit Terminal Block dimensions.....	47
Figure 3-12: RS232C Cable for PC Connection wiring diagram – MX without USB.....	52
Figure 3-13: USB Connector pin orientation.....	53
Figure 3-14: Multi-Cabinet DIP Switch Location and Setting	55
Figure 3-15: Functional Test Setup.....	61
Figure 3-16: 7003-416-1 Output Junction Box.....	63
Figure 3-17: 7003-424-1 Output noise filter box.....	64
Figure 4-1: Shuttle Knob.....	67
Figure 4-2: FUNCTION Keypad.....	68
Figure 4-3: Measurement Screen	69
Figure 4-4: PROGRAM Menu	75
Figure 4-5: CONTROL Menu	77
Figure 4-6: MEASUREMENT Screen	80
Figure 4-7: Selecting a Waveform	97
Figure 4-8: Custom Waveform Creation with GUI Program.....	98
Figure 4-9: Waveform Crest Factor Affects Max. rms Voltage	99
Figure 4-10: Pulse Transients.....	105
Figure 4-11: List Transients	106
Figure 4-12: Sample Transient Output Sequence	107
Figure 4-13: Switching Waveforms in a Transient List.....	108
Figure 4-14: TRANSIENT Menu	109
Figure 5-1: MX Series Functional Block Diagram.....	110
Figure 5-2: MX Series Detailed Block Diagram	113
Figure 5-3: Power Module Detailed Block Diagram.....	114
Figure 5-4: Power Module Layout.....	116
Figure 5-5: Amplifier Board Layout.....	118
Figure 6-1: Calibration Setup MX45-1 (Rear view).....	122
Figure 9-1: Application Menu	142
Figure 9-2: DO160 Main Menus.....	143
Figure 9-3: Normal state screens.....	143
Figure 9-4: Voltage Modulation - Frequency characteristics.....	146
Figure 9-5: Frequency Modulation	147
Figure 9-6: Power Interrupt	148
Figure 9-7: Power Interrupt for Group2/A(NF) and Group3/A(WF).....	149
Figure 9-8: Emergency Screens	151
Figure 9-9: Abnormal Screen.....	152
Figure 9-10: Applications Menu	157
Figure 9-11: MIL704 Menu.....	157
Figure 9-12: Steady State Menu	158
Figure 9-13: Emergency Menu.....	161
Figure 9-14: Abnormal Screens	162
Figure 9-15: MIL704 DC Menu.....	164
Figure 9-16: Steady State DC.....	164
Figure 9-17: Transient Menu.....	165
Figure 9-18: Abnormal Test Screen.....	166
Figure 9-19: Emergency Test.....	167
Figure 9-20: Watt-Hour Meter Screen.....	169

Figure 9-21: WH-Meter Screen with Function Active 169

List of Tables

Table 3-1: Suggested Input Wiring Sizes for each MX Cabinet * 38

Table 3-2: Suggested Output Wiring Sizes * 41

Table 3-3: System Interface Connectors 49

Table 3-4: Analog Interface Connector 49

Table 3-5: BNC Connectors 50

Table 3-6: External Sense Connector 50

Table 3-7: RS232 Connector pin out – MX with RS232 and USB 51

Table 3-8: RS232C Connector pin out – MX with RS232 but no USB 51

Table 3-9: USB Connector pin out. 53

Table 3-10: RJ45 LAN Connector pin out. 54

Table 3-11: Clock and Lock Configuration settings 57

Table 3-12: Clock and Lock Initialization settings 58

Table 4-1: Menu Tree 74

Table 4-2: Sample Transient List 107

Table 6-1: Calibration Load Values 123

Table 6-2: Measurement Calibration Table 124

Table 6-3: Output Calibration Table – MX15 Series 125

Table 6-4: Programmable Z adjustment pots 128

Table 6-5: Formulas to calculate R and L 128

Table 7-1: Basic Symptoms 129

Table 7-2: MX Fuse Ratings 134

Table 7-3: Flash Down load Messages 136

Table 8-1: Replaceable Parts 138

Table 8-2: Fuses 139

Table 9-1: Normal Voltage and Frequency minimum 144

Table 9-2: Normal Voltage and Frequency Maximum 144

Table 9-3: Airbus mode voltage modulation 145

Table 9-4: Normal Voltage Surge Sequence 149

Table 9-5: Normal Frequency Transient Sequence 150

Table 9-6: Normal Frequency Variation Sequence 150

Table 9-7: Emergency Voltage and Frequency Minimum 151

Table 9-8: Emergency Voltage and Frequency Maximum 151

Table 9-9: Abnormal Voltage Minimum 152

Table 9-10: Abnormal Voltage Maximum 152

Table 9-11: Abnormal Frequency Transient 154

Table 9-12: Steady state voltage 158

Table 9-13: Steady state frequency 159

Table 9-14: Frequency Modulation 159

Table 9-15: Abnormal Over Frequency 163

Table 9-16: Abnormal Under Frequency 163

Table 10-1: Error Messages 174

1 Introduction

This instruction manual contains information on the installation, operation, calibration and maintenance of all power systems that use the MX15 Series power sources with the programmable controller.

1.1 General Description

The MX15 Series AC and DC power source systems are high efficiency, floor standing AC and DC power sources that provide a precise output with low distortion. Available voltage ranges are 150 Vac, 300 Vac and 400 Vac in AC mode and 200 Vdc and 400 Vdc in DC mode.

Models with a -1 designation provide full front panel operation but do not include certain features such as arbitrary waveform generation unless added as an option at the time of order. Models with the Pi controller offer several additional standard features, including the RS232C, USB, LAN (option) and IEEE-488 interfaces, arbitrary waveform generation, dual voltage ranges and additional measurement functions.

The MX15 Series units are contained in a compact floor standing enclosure on casters. This allows the units to be moved around more easily.

Read the installation instructions carefully before attempting to install and operate the MX15 Series power systems.

1.2 Manual organization and format

All user documentation for California Instruments power sources is provided on CDROM in electronic format. (Adobe Portable Document Format) The required Adobe PDF viewer is supplied on the same CDROM. This manual may be printed for personal use if a hardcopy is desired. To request a hardcopy from California Instruments, contact customer service at support@calinst.com. There will be an additional charge for printed manuals.

This manual contains sections on installation, normal use, maintenance and calibration. If the MX system is equipped with a GPIB, RS232C, USB or LAN interface, refer to the MX Programming manual for information on using the remote control interfaces and command syntax. The programming manual is provided on the same CDROM as this user manual.

2 Specifications

Specifications shown are valid over an ambient temperature range of $25 \pm 5^\circ \text{C}$ and apply after a 30 minute warm-up time. Unless otherwise noted, all specifications are for sine wave output into a resistive load.

2.1 Electrical

2.1.1 Input

Parameter	MX15	MX30/2	MX45/3
Line Voltage: (3 phase, 3 wire + ground (PE))		208 $V_{LL} \pm 10\%$ 230 $V_{LL} \pm 10\%$ 400 $V_{LL} \pm 10\%$ 480 $V_{LL} \pm 10\%$	
Line VA:	18 KVA	35 KVA	53 KVA
Line Current:	58 A_{RMS} @ 187 V_{LL} 52 A_{RMS} @ 207 V_{LL} 30 A_{RMS} @ 360 V_{LL} 25 A_{RMS} @ 432 V_{LL}	Each MX15 chassis requires its own AC service. Total Line currents are 2 x MX15	Each MX15 chassis requires its own AC service. Total Line currents are 3 x MX15
Line Frequency:	47-63 Hz		
Efficiency:	85 % (typical) depending on line and load		
Power Factor:	0.95 (typical) / 0.99 at full power.		
Inrush Current:	77 A_{pk} @ 208 V_{LL} 73 A_{pk} @ 230 V_{LL} 44 A_{pk} @ 400 V_{LL} 37 A_{pk} @ 480 V_{LL}	Each MX15 chassis requires its own AC service. Total Peak currents are 2 x MX15	Each MX15 chassis requires its own AC service. Total Peak currents are 3 x MX15
Hold-Up Time:	> 10 ms		
Isolation Voltage:	2200 VAC input to output 1350 VAC input to chassis		

2.1.2 Output

Note: All specifications are for AC and DC unless otherwise indicated.

Output Parameter	MX15	MX30/2	MX45/3
Modes			
Std Controller	AC, DC		
Pi Controller	AC, DC, AC+DC		
Voltage:			
Ranges (L-N):			
AC Mode	Low: 0 - 150 V / High: 0 - 300 V		
DC Mode	Low: 0 - 200 V / High: 0 - 400 V		
AC+DC Mode	AC: Low: 0 - 150 V / High: 0 - 300 V DC Offset: Low Vrange: 0 - 150 V High Vrange: 0 - 220 V		
Resolution:			
AC Mode	0.1 V		
DC Mode	0.1 V		
AC+DC Mode	AC: 0.1 V DC Offset: 0.01 V		
Accuracy:	± 0.3 V AC mode ± 1 V DC mode		
Distortion THD ¹ : (Resistive load)	< 1 % @ 16 - 66 Hz < 2 % @ 66 - 500 Hz < 3 % @ > 500 Hz		
Load Regulation:	0.25 % FS @ DC - 100 Hz 0.5 % FS @ > 100 Hz		
Line Regulation:	0.1% for 10% input line change		
DC Offset Voltage:	< 20 mV		
Output Noise: (20 kHz to 1 MHz)	< 2 V _{RMS} low V Range < 3 V _{RMS} high V Range		
Output Coupling	DC coupled Except on optional -HV or -XV Voltage range output, which is AC coupled.		
Power (total power for all phases, either range, at full scale voltage)			
AC Mode	15 KVA	30 KVA	45 KVA
DC Mode	10 KW	20 KW	30 KW
AC+DC Mode	The maximum power and current in the AC+DC mode is equal to that in the DC mode		
Current			
Note: Current, maximum amps indicated per phase available between 50 and 100 % of voltage			

¹ The distortion specification for the MX Series is valid for resistive load conditions.

Output Parameter	MX15	MX30/2	MX45/3
range.			
Constant Power Mode: Operation at higher currents but constant power is possible from 80% of Voltage range (125% of max. current) declining to 100% of maximum current at 100 % of voltage range for short periods of time or at reduced ambient temperatures. (< 15 mins @ 30° C). See Figure 2-2 and Figure 2-4.			
AC Mode	MX15-1 V Lo: 100 A V Hi: 50 A	MX30/2-1 V Lo: 200 A V Hi: 100 A	MX45/3-1 V Lo: 300 A V Hi: 150 A
DC Mode AC+DC Mode	MX15-1 V Lo: 50 A V Hi: 25 A	MX30/2-1 V Lo: 100 A V Hi: 50 A	MX45/3-1 V Lo: 150 A V Hi: 75 A
Note: Current derates linearly from 50% of voltage range to 20% of specified current at 5% of voltage range			
Current Limit mode	Programmable, CC or CV mode		
Repetitive Peak Current			
AC Mode	MX15-1 V Lo: 300 A V Hi: 150 A	MX30/2-1 V Lo: 600 A V Hi: 300 A	MX45/3-1 V Lo: 900 A V Hi: 450 A
Frequency			
Range:	Standard: 16 Hz - 819.0 Hz -LF option: 16 Hz - 500.0 Hz -HF option: 16 Hz – 1000 Hz		
Resolution:	0.01 Hz 0.1 Hz 1 Hz	from 16.00 to 81.91 Hz from 82.0 to 819.0 Hz from 819 to 1000 Hz	
Accuracy:	± 0.01 %		
Ext. Sync Mode			
Input:	Isolated TTL input for external frequency control. Requires 5V at 5 mA for logic high.		
Accuracy:	Ext. Sync to phase A with fixed Ext. Sync Frequency input: 16 Hz - 100 Hz: < 2° 100 Hz - 500 Hz: < 3° > 500 Hz: < 4°		
Programmable Output Impedance			
Range:	R: 1 – 200 mOhm L: 15 – 200 uH	N/A	N/A
Resolution:	R: 1 mOhm L: 1 uH	N/A	N/A
Accuracy:	10 % FS	N/A	N/A

Note: Output specifications apply below the Current / Voltage rating lines shown in the V/I rating chart below.

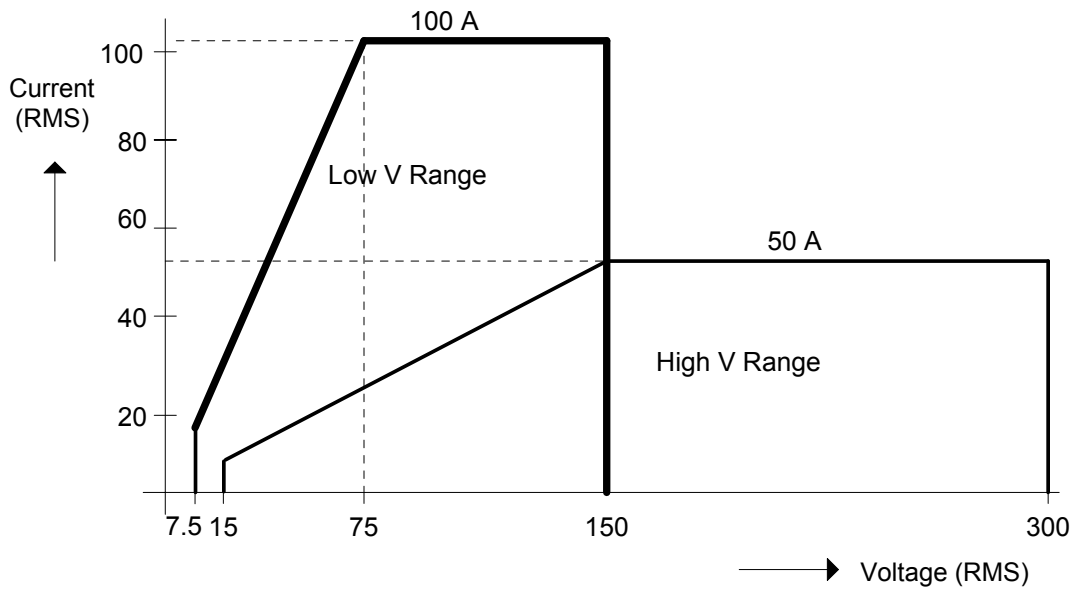

Figure 2-1: MX15-1 Voltage / Current Rating Chart for 150/300 V AC Ranges – Max Rating.

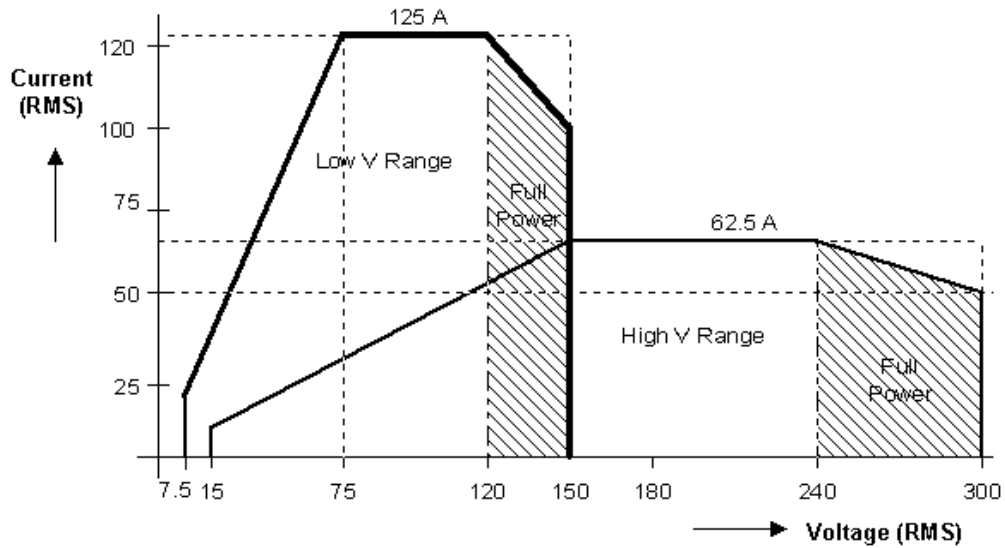

Figure 2-2: Voltage / Current Rating Chart for 150/300 V AC Ranges – Derated.

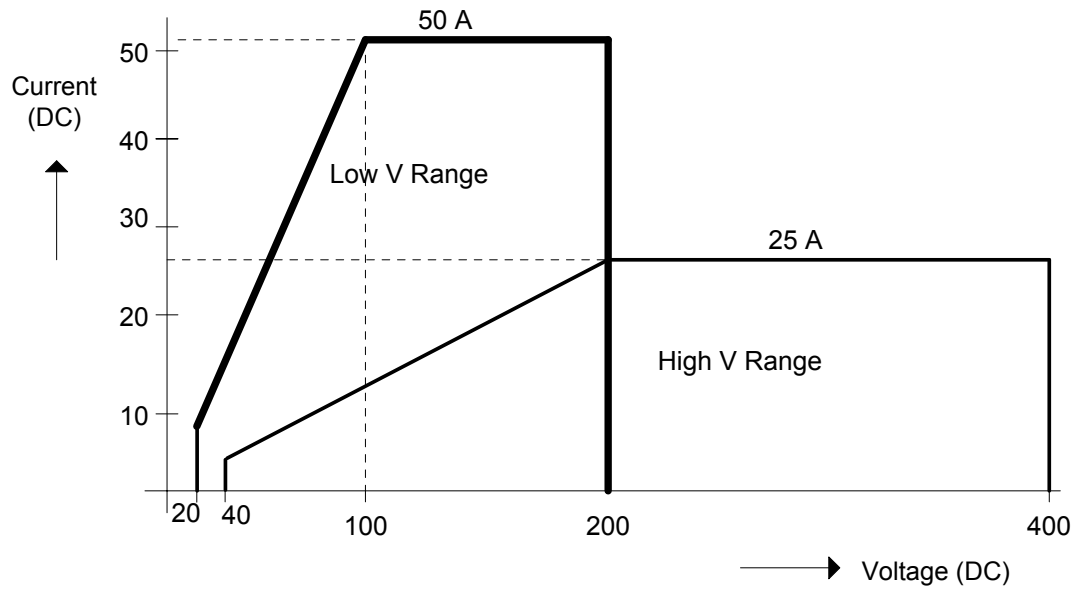

Figure 2-3: MX15-1 Voltage / Current Rating Chart for 200/400 V DC Ranges – Max. Rating

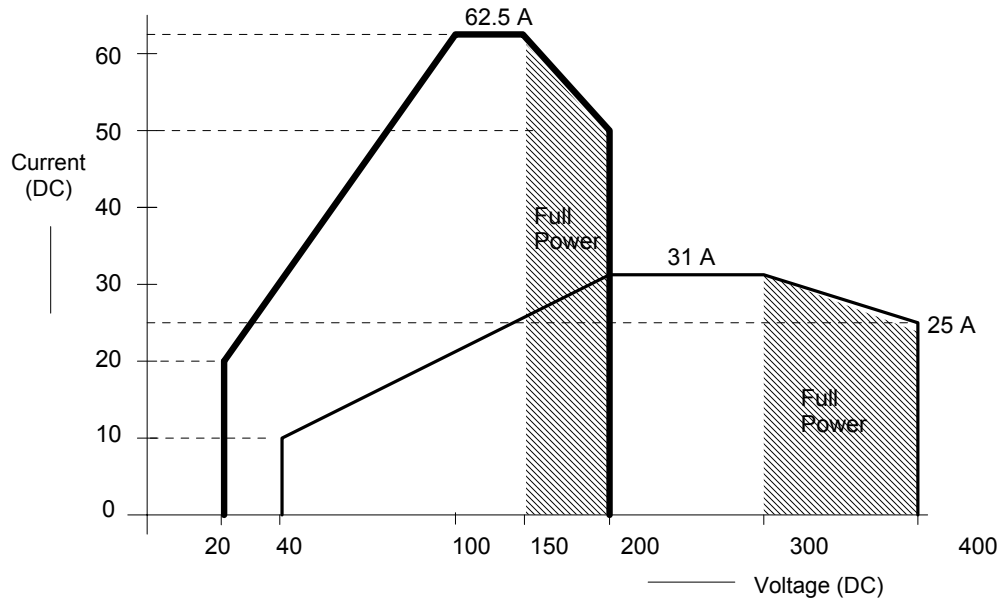

Figure 2-4: Voltage / Current Rating Chart for 200/400 V DC Ranges – Derated

2.1.3 AC Measurements

Measurement specifications apply to MX15-1 / MX15-1Pi. See notes for other models and configurations.

Parameter	Range	Accuracy (±)	Resolution
Frequency	16.00 - 820.0 Hz	0.01% + 0.01 Hz	0.01 to 81.91 Hz 0.1 to 500 Hz
RMS Voltage	0 - 400 Volts	0.05V + 0.02%, <100 Hz 1V + 0.02%, 100-820 Hz	0.01 Volt
RMS Current	0 - 150 Amps	0.15A + 0.02%, <100 Hz 3A + 0.02%, 100-820 Hz	0.01 Amp
Peak Current	0 - 400 Amps	0.15A + 0.02%, <100 Hz 3A + 0.02%, 100-820 Hz	0.01 Amp
VA Power	0 - 15 KVA	30 VA + 0.1%, <100 Hz 60 VA + 0.1%, 100-820 Hz	10 VA
Real Power	0 - 15 KW	30 W + 0.1%, <100 Hz 60 W + 0.1%, 100-820 Hz	10 W
Power Factor (>0.2kVA)	0.00 - 1.00	0.01, <100 Hz 0.02, 100-820 Hz	0.01
Note: Accuracy specifications are valid above 100 counts.			
Note: Power factor accuracy applies for PF > 0.5 and VA > 50 % of max.			

2.1.4 DC Measurements

Parameter	Range	Accuracy (\pm)	Resolution
Voltage	0 - 400 Volts	0.5 Volts	0.1 Volt
Current	0 - 400 Amps	0.5 Amps	0.01 Amp
Power	0 - 10 kW	30 W	10 W
Note: Accuracy specifications are valid above 100 counts.			

2.1.5 Harmonic Measurements (Pi controller)

Parameter	Range	Accuracy (\pm)	Resolution
Frequency fundamental	16.00 - 820 Hz	0.03% + 0.03 Hz	0.01 Hz
Frequency harmonics	32.00 Hz – 16 KHz	0.03% + 0.03 Hz	0.01 Hz
Phase	0.0 - 360.0°	2° typ.	0.5°
Voltage	Fundamental	0.75V	0.01V
	Harmonic 2 - 50	0.75V + 0.3% + 0.3%/kHz	0.01V
Current	Fundamental	0.5A	0.1A
	Harmonic 2 - 50	0.15A + 0.3% + 0.3%/kHz	0.1A

2.1.6 System Specification

Parameter	Specification
External Modulation:	0 to 10%
Synchronization Input:	Isolated TTL input for external frequency control. Requires 5V at 5 mA for logic high.
Trigger Input:	External trigger source input. Requires TTL level input signal. Triggers on negative edge. Response time 80 - 100 μ s.
Trigger Output:	Programmable through transient list system. 400 μ s pulse for voltage or frequency change. Isolated TTL output. Output reverts to Function strobe when not used as Trig Out. This function is mutually exclusive with the Function Strobe output.
Function Strobe:	Active for any voltage or frequency program change. 400 μ s pulse for voltage or frequency change. Isolated TTL output. This function is mutually exclusive with the Trigger Output. Same output is used for Trigger Output if Trigger Output is programmed as part of list system.
Output Status:	Monitors status of output relay. Isolated TTL output. High if output relay is closed, low if output relay is open.
Non volatile memory storage:	16 complete instrument setups and transient lists, 100 events per list.
Waveforms	Sine (Models with Standard controller) Sine, square, clipped, user defined (Models with Pi controller)
Transients	Voltage: drop, step, sag, surge, sweep

Parameter	Specification
	Frequency: step, sag, surge, sweep Voltage and Frequency: step, sweep
IEEE-488 Interface:	SH1, AH1, T6, L3, SR1, RL2, DC1, DT1 IEEE 488.2 and SCPI Response time is 10 ms (typical)
RS232C Interface:	Bi-directional serial interface 9 pin D-shell connector Handshake: CTS, RTS Data bits: 7, 8 Stop bits: 1,2 Baud rate: 9600 to 115,200 bps Syntax: IEEE 488.2 and SCPI
USB Interface:	Standard USB 2.0 peripheral. Data transfer rate: 460,800 bps Syntax: IEEE 488.2 and SCP. Note: Not available on older MX models.
LAN Interface:	Option –LAN. When the LAN interface is installed, the RS232 interface is disabled. RJ45 Connector, 10BaseT, 100BaseT or 1000BaseT, Data transfer rate: 460,800 bps Protocol: TCP/IP. Syntax: IEEE 488.2 and SCP Note: Disconnect any USB connection when using the LAN interface.
Current Limit Modes:	Two selectable modes of operation: 1. Constant current mode (voltage folds back with automatic recovery) 2. Constant voltage mode with trip-off (Relays open).

2.1.7 Unit Protection

Input Over current:	In-line fast acting fuses. Check fuse rating in Service and Maintenance section. Ratings will depend on AC input configuration settings. Circuit breaker for LV supply.
Input Over voltage:	Automatic shutdown.
Input Over voltage Transients:	Surge protection to withstand EN50082-1 (IEC 801-4, 5) levels.
Output Over current:	Adjustable level constant current mode with programmable set point.
Output Short Circuit:	Peak and RMS current limit.
Over temperature:	Automatic shutdown.

2.2 Mechanical

Parameter	Specification
Dimensions: (for each MX chassis)	Height: 31.75" 806 mm Width: 24" 610 mm Depth: 28" 711 mm
Unit Weight: (for each MX chassis)	Net: 600 lbs / 272 Kg <i>approximately</i> Shipping: 681 lbs / 309 Kg <i>approximately</i>
Material:	Steel chassis with aluminum panels and covers.
Finish:	Light textured painted external surfaces. Panels semi-gloss polyurethane color no. 26440 (medium gray)
Cooling:	Fan cooled with air intake on the front and exhaust to the rear. Fans: 2 x 225CFM. Air displacement 7.5 Cu Ft/sec. Max.
Internal Construction:	Modular sub assemblies.
Rear Panel Connections:	(See section 3 for description of connections) <ul style="list-style-type: none"> • Cable entry and strain relieve for AC input wiring • Cable entry and strain relieve for output wiring • External sense terminal block (Remote voltage sense) • System interface (2x) • Clock and Lock BNC's (requires -LKM or -LKS options) • RS232, USB, GPIB, LAN (option) • Trigger In BNC • Trigger Out BNC • Function Strobe BNC • Output Status

2.3 Environmental

Parameter	Specification
Operating Temp:	0° to +40° C. (Except in CP mode). +32° to +104° F.
Storage Temp:	-40° to +85 °C. -40° to +185° F.
Altitude:	< 2000 meters
Relative Humidity:	0-95 % RAH, non-condensing maximum for temperatures up to 31°C decreasing linearly to 50% at 40°C.
Installation/Over voltage Category:	II
Pollution Degree:	2
Indoor Use Only	
Vibration:	Designed to meet NSTA 1A transportation levels.
Shock:	Designed to meet NSTA 1A transportation levels.

2.4 Regulatory

Electromagnetic Emissions and Immunity:	Designed to meet EN50081-2 and EN50082-2 European Emissions and Immunity standards as required for the “CE” mark.
Acoustic Noise:	56 dBA maximum at 0% to 50% load, 68 dBA maximum greater than 50% load to 100% load. Measured at one meter.
Safety:	Designed to EN 61010-1 European safety standards as required for the “CE” mark.

2.5 Front Panel Controls

Controls:	
Shuttle knob:	Allows continuous change of all values including output calibration and range change.
Decimal keypad:	A conventional decimal keypad facilitates quick entry of numerical values such as voltage, current limit, etc. The large blue enter key will make the value you enter effective. Using the SET key allows the user to preset all parameter values and update them all at once by pressing the Enter key.
Up/down arrow keys:	A set of up and down arrow keys is used to move the cursor position in all menus. This allows quick selection of the desired function or parameter.
Function keys:	Measure key will display most measurement values. Program key will show all program parameters. Output on/off key for output relay control. Phase key will switch display to show program and measured values for each phase (not used on MX15).

Displays:	
LCD display:	A two-line LCD display with backlight provides easy to read guidance through all setup operations. An adjustable viewing angle makes it easy to read from all practical locations.
Status indicators:	Bright status indicators inform the user of important power source conditions. The Remote lamp informs the user that the unit is under remote control. The Overload lamp indicates that excessive current is being drawn at the output. The Over temperature lamp illuminates when internal heat sink temperatures are too high. The Hi Range indicator is lit any time the unit is switched to the high voltage range. The Output On/Off indicator is on when the power source output relays are closed.

2.6 Special Features and Options

Controller Features	
Mode:	This option is not available for the MX15.
Parallel Operation:	Up to three units can be paralleled in a single-phase configuration (with one master controller and one or two auxiliary units). (MX30/2 and MX45/3). Only the master unit requires a controller in this setup. The auxiliary units are controlled through the system interface.
Clock and Lock Mode: (Option -LKM and -LKS required).	Up to three units (all with controllers) can be connected in a one, two, or three-phase configuration using CLOCK and LOCK connections. Each unit requires its own controller in this configuration. One unit acts as the master and provides the reference clock to the auxiliary units.
Controller:	Programmable controller front panel assembly.
Output Relay:	Standard output relay feature to isolate power source from the load.
Output On/Off:	The output relay can be used to quickly disconnect the load. An amber status indicator displays the status of the output relay.
Firmware Options	
- 704	Mil Std 704D & E test firmware. Mil Std 704A, B, C, & F test software (refer to Avionics Software Manual P/N 4994-971 for details). Note: Requires use of MXGui Windows application software provided on CD ROM CIC496.
- 160	RTCA/DO-160D test firmware RTCA/DO-160E test software (refer to Avionics Software Manual P/N 4994-971 for details). Note: Requires use of MXGui Windows application software provided on CD ROM CIC496.
- 787	Boeing 787 Test software (refer to Avionics Software Manual P/N 4994-971 for details). Note: Requires use of MXGui Windows application software provided on CD ROM CIC496.
-ABD	Airbus ABD0100.1.8 Test software (refer to Avionics Software Manual P/N 4994-971 for details). Note: Requires use of MXGui Windows application software provided on CD ROM CIC496.
-WHM	Watt Hour Measurements (Accuracy and Resolution. See Sec. 2.6.5.)
Output Voltage Range Options	

- HV	Adds 400 V AC only output range.
- XV	Adds customer specified AC only output range. Contact factory for details.
Misc. Options	
-ES	<p>Emergency Shut off switch. This option key lock push button is installed on the front panel of the master MX if ordered with the MX system. When pushed in, the main AC contactor is opened disconnecting the AC input power to the MX input transformer. Note that the controller (and LCD display) will still be powered up but no power is available to the amplifiers and there will be no output power either. The controller runs off the LV supply, which must be turned off with the front panel breaker.</p> <p>After the ES has been pushed, the provided key will be required to release it. Once the ES button has been released, the MX must be powered down using the front panel circuit breaker and turned back on to start up again.</p> <p>Note: Do not misplace the 2 keys provided, as no duplicates are available from CI. If lost, the ES switch must be replaced. In that case, contact California Instruments customer service. (support@calinst.com).</p>
-MB	Multi-box Option. Provides additional controllers in Auxiliary units of multi-cabinet configurations (MX30/2, MX45/3) to allow individual MX15 units to be used stand-alone.
-LF	Limits maximum output frequency to 500 Hz.
-HF	Increases maximum output frequency to 1000 Hz.
External Accessories (External to MX chassis)	
7003-416-1	Input / Output wiring junction box. Connects two to six three-phase MX45 cabinet outputs, neutral and ground to a common output terminal block housed in a metal enclosure junction box. Can also be used to connect multiple MX chassis to common AC input service. See section 3.13 for details.
7003-424-1	Output noise filter, 3 phase + neutral. May be used to reduce output noise of MX15 when testing EUT's for conducted emissions. This is an external filter that attenuates the 250 KHz ripple frequency on the MX output by > 20 dB. The filter is rated for 125A per phase and 800 Hz.

2.6.1 -HV Option Specifications

The -HV option provides an AC only output range of 0 to 400 Vac L-N. Specifications unique to the -HV option are shown in the table below.

Output Parameter	MX15	MX30/2	MX45/3
Modes			
Pi Controller	AC		
Voltage:			
Ranges (L-N):	0 -400 V		
Resolution:	0.1 V		
Accuracy:	± 0.4 V		
Output Coupling	AC coupled		
Power (total power for all phases, either range, at full scale voltage)			
AC Mode	15 KVA	30 KVA	45 KVA
Current			
Note: Current, maximum amps per phase available between 50 and 100 % of voltage range.			
	MX15-1 37.5 A	MX15-1 75 A	MX15-1 112.5 A
Peak Current			
AC Mode	MX15-1 112.5 A	MX15-1 225 A	MX15-1 337.5 A

Note: Output specifications apply below the Current / Voltage rating lines shown in the V/I rating chart below.

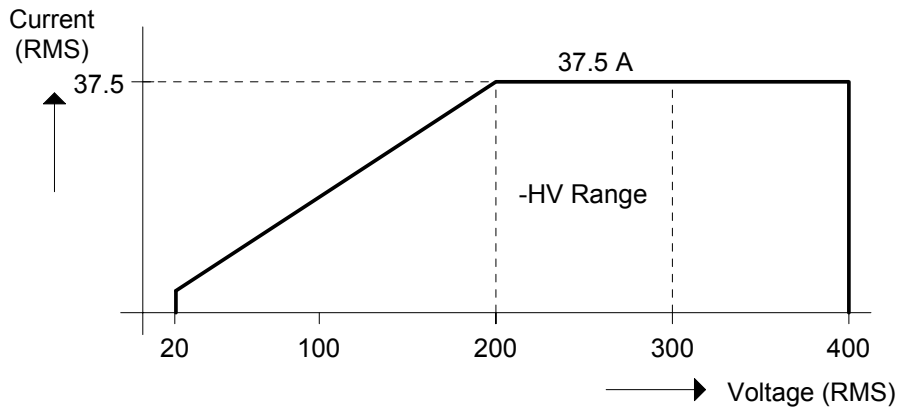

Figure 2-5: MX15-1 Voltage / Current Rating Chart, -HV Option – Max. Rating.

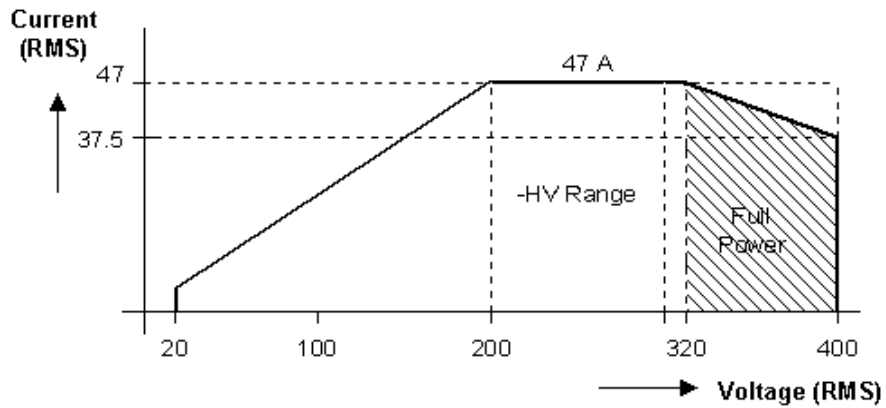

Figure 2-6: Voltage / Current Rating Chart, -HV Option – Derated.

2.6.2 -XV Option Specifications

Consult factory for -XV option specifications.

2.6.3 -HF Option Specifications

The -HF option extends the maximum available output frequency from 819 Hz to 1000 Hz. Some restrictions are in effect at this increased output frequency level.

All other specifications of the MX15 system remain unchanged if this option is installed except as noted in the table below.

-HF Option:	
Frequency	
Range:	-HF option: 16 Hz - 1000 Hz
Resolution:	0.01 Hz < from 16.00 to 81.92 Hz 0.1 Hz > from 82.0 to 819.2 Hz 1 Hz > from 820 to 1000 Hz
Accuracy:	± 0.01 %
Phase	
Accuracy:	16 - 100 Hz: < 1.5° 100 - 500 Hz: < 2° 500 - 819 Hz: < 4° 819 - 1000 Hz: < 5°
Voltage	
High Voltage Range	Maximum voltage at 1000 Hz is 250 Vrms Maximum frequency at 300 Vrms is 875 Hz See Figure 2-7
Low Voltage Range	Maximum voltage at 1000 Hz is 125 Vrms Maximum frequency at 150 Vrms is 875 Hz See Figure 2-8.
-HV Voltage Range	Maximum voltage at 1000 Hz is 333 Vrms Maximum frequency at 400 Vrms is 875 Hz .
	Note: If the voltage or frequency settings shown here are exceeded for any length of time (> 1 sec), the MX may shut down generating an over temperature fault to protect itself.

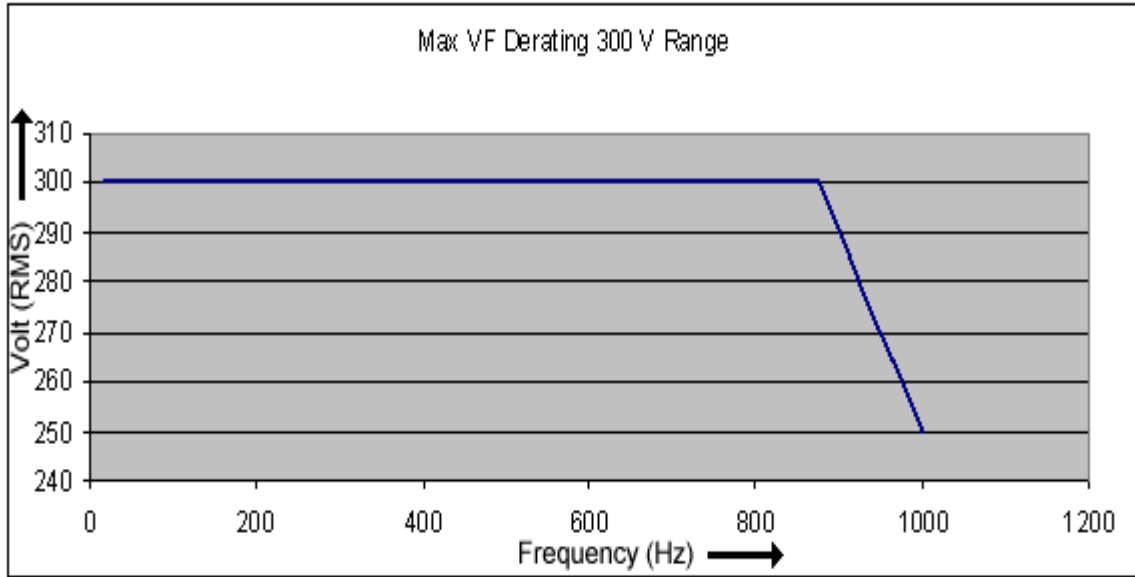

Figure 2-7: -HF Option Voltage Frequency Rating 300V range

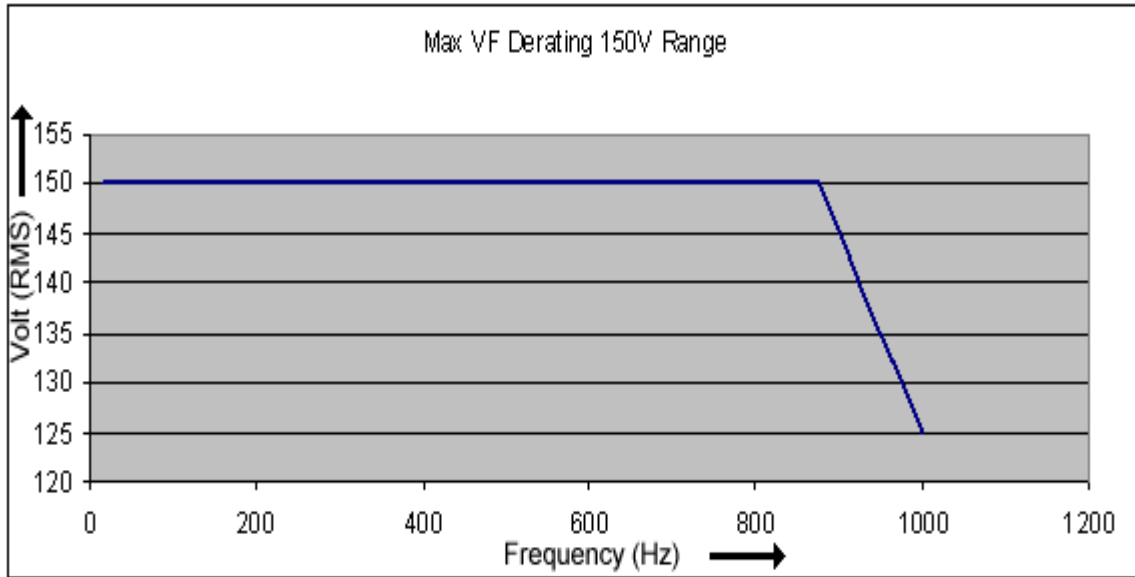

Figure 2-8: -HF Option Voltage Frequency Rating 150V range

2.6.4 -LF Option Specifications

The -LF option limits the maximum available output frequency to 500 Hz. All other specifications of the MX15 system remain unchanged if this option is installed.

2.6.5 WHM Option Specifications

Watt-hour measurement mode:

Accuracy:

0-6.000KW	0.01KWH + 0.1%	<100 Hz
	0.02KWH +0.1%	100-819 Hz
>6.000KW	Times three of the above specification	

Resolution:

0.001 KWH

2.7 Supplemental Specifications

Supplemental specifications are not warranted and generally reflect typical performance characteristics. These characteristics have been checked on a type test basis only and are not verified on each unit shipped. They are provided for reference only.

2.7.1 Output

Output Parameter	MX15	MX30/2	MX45/3
Voltage:			
Slew rate:	> 0.5 V/micro sec		
Stability:	0.25 % over 24 hour period at constant line, load and temperature.		
Settling time:	< 0.5 msec		
Frequency:			
Temperature coefficient:	± 5ppm per degree C		
Stability:	± 15 ppm per year		
Current:			
Constant Power Mode:	Operation at higher currents but constant power is possible from 80% of Voltage range (125% of max. current) declining to 100% of maximum current at 100 % of voltage range for short periods of time or at reduced ambient temperatures. (< 15 mins @ 30° C). See Figure 2-2 and Figure 2-4.		

2.7.2 Acoustic Noise Levels

Acoustic Noise:	Measured at a distance of one meter. (3 ft.)
Front	53 dBA at no load to 65 dBA at full load.
Back	55 dBA at no load to 67 dBA at full load

2.7.3 Output Noise Spectrum

The MX series is a switching power supply and as such will have a certain amount of switching noise at its output. While the overall RMS noise is specified, the specific noise spectrum will differ slightly from unit to unit. The information provided in this section is for reference only.

The output noise can be reduced by using one or more external filters. A suitable filter is the P/N 7003-424-1 (Figure 2-9) available from California Instruments as an option. Attenuation at the 250 kHz ripple frequency is 20 dBuV. The output voltage drop at 800 Hz full load is less than 1Vrms.

Typical output noise spectrum for a standard MX45-3Pi in three phase mode operating at 400 Hz is shown in Figure 2-10 for phase A and Neutral. The same output with the use of the optional filter is shown in Figure 2-11. For connection information, refer to section 3.14. The MX15 and MX45 use the same amplifier so results will be similar.

MX Filter Specifications (Model 7003-424-1)	
Type	
Low Pass Filter	Three phase WYE, four wire. (A, B, C and Neutral)
Capability	
Frequency range	DC, 16 Hz - 800 Hz
Max Voltage	250 Vrms Line to Neutral / 440 Vrms L-L
Phase Current	125 Arms per phase maximum.
Impedance	Voltage drop at 800 Hz, 125 A is less than 1 Vrms.
Performance	
Attenuation	20 dBuV at 250 KHz.
Physical	
Enclosures type	Cooper B-Line P/N 16126 SC NK
Dimensions (W x D x H)	Unit: 16" x 12" x 6" / 406 mm x 305 mm x 152 mm Shipping: 30" x 25" x 11" / 760 mm x 635 mm x 280 mm
Weight	Net: 28 lbs / 12.7 Kg Shipping: 40 lbs / 18.2 Kg
Operating Temp:	0° to +40° C. / +32° to +104° F.

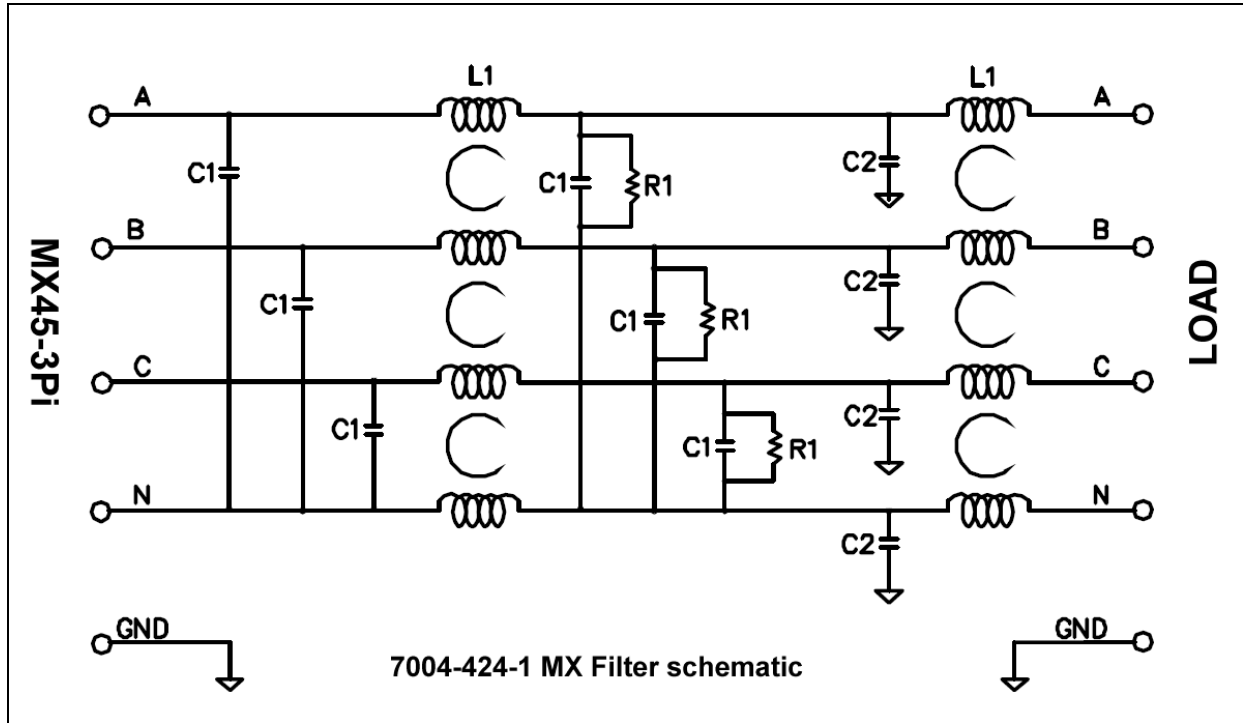

Figure 2-9: MX output filter option schematic

MX45 Output Noise Spectrum - No EMI Filter

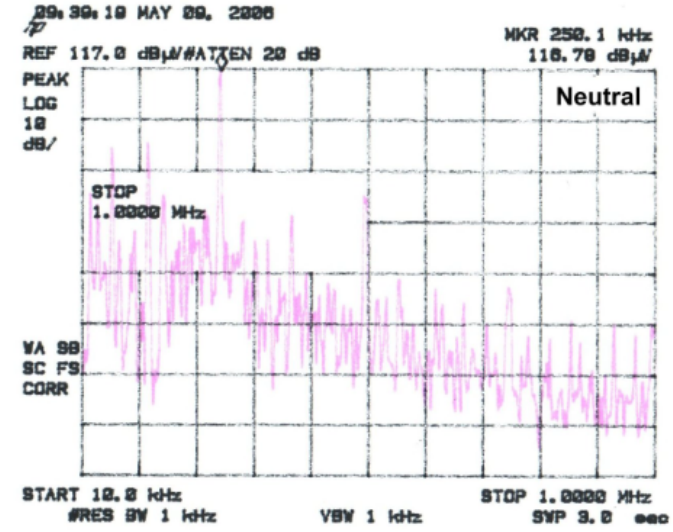
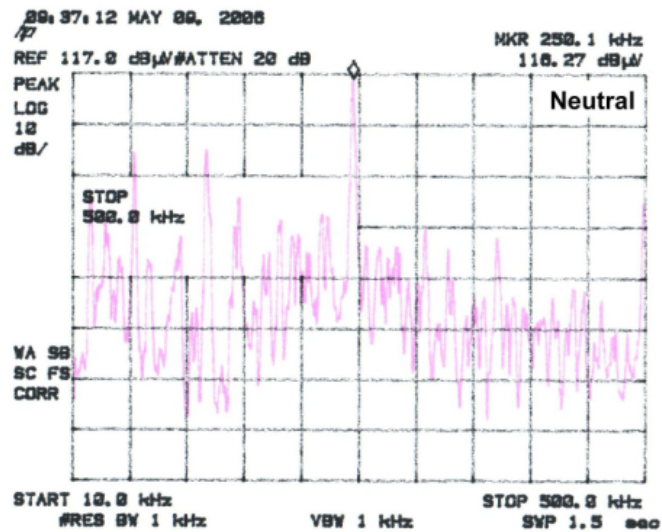
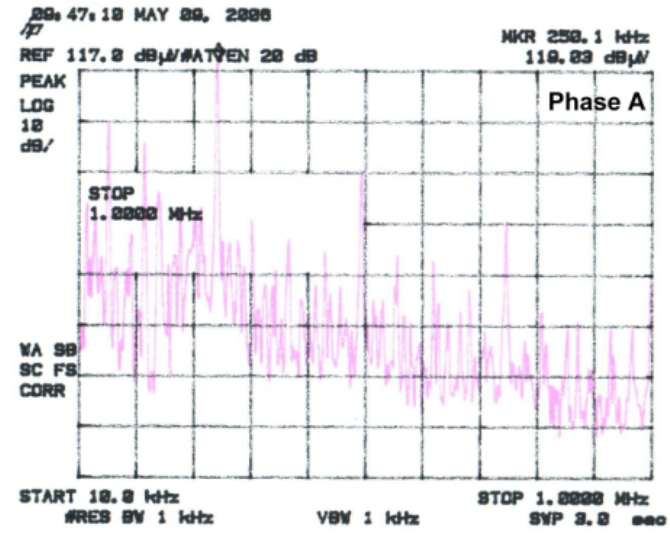
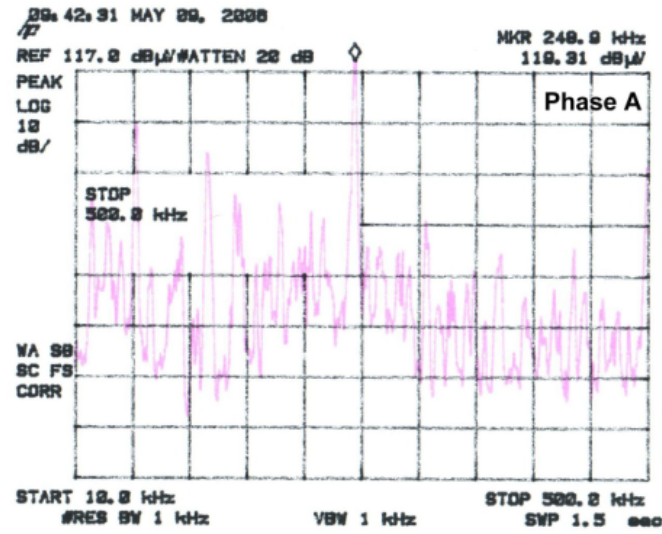

Figure 2-10: MX45 Output Noise 10 KHz – 1 MHz

MX45 Output Noise Spectrum with EMI Filter SF1917

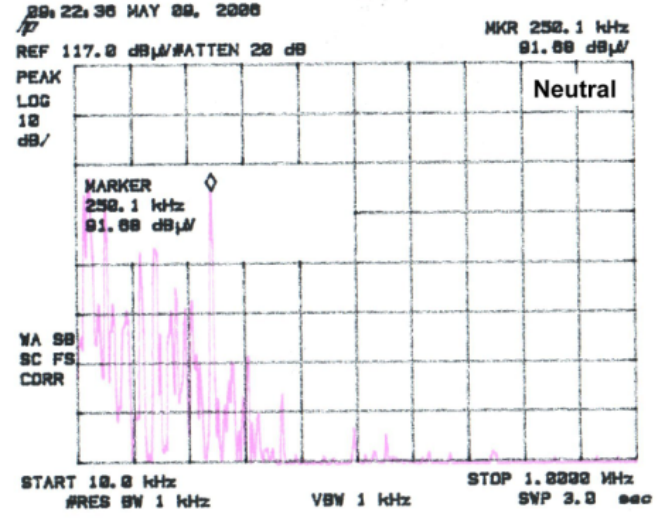
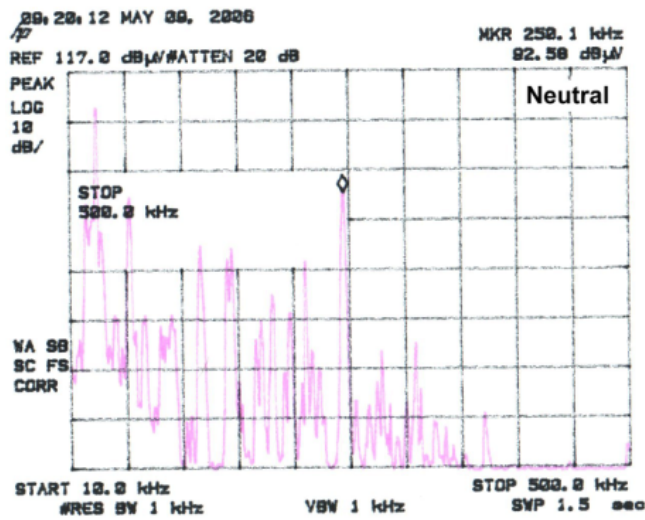
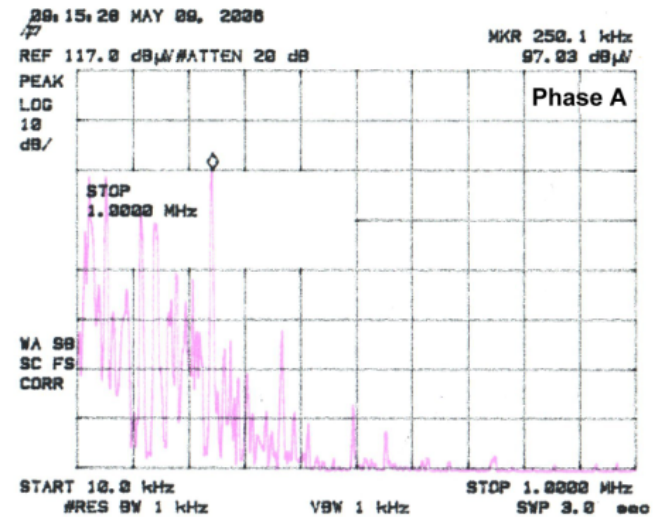
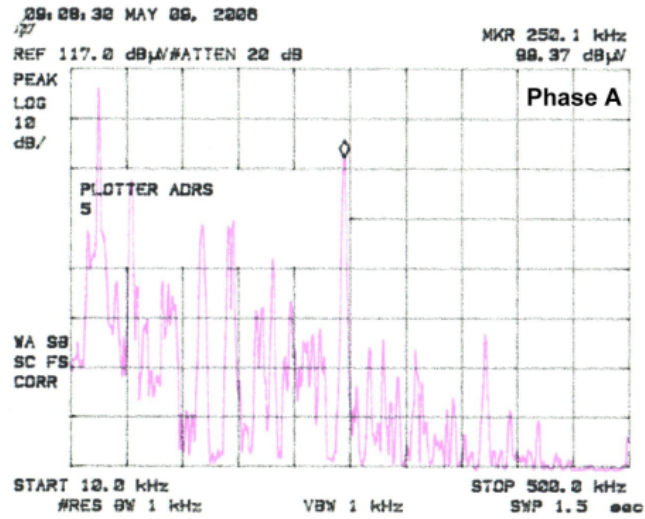

Figure 2-11: MX45 Output Noise 10 KHz - 1 MHz with optional Filter

3 Unpacking and Installation

3.1 Unpacking

Inspect the unit for any possible shipping damage immediately upon receipt. If damage is evident, notify the carrier. **DO NOT** return an instrument to the factory without prior approval. Do not destroy the packing container until the unit has been inspected for damage in shipment. If possible, **retain the container** (wooden crate) in the event the system ever has to be returned to the factory for either repair or upgrades



WARNING: This power source weighs approximately 600 lbs / 272 Kg. Obtain adequate help when moving the unit. Make sure the location (floor) in which the MX Series unit(s) will be installed can support the weight of the unit(s).

3.2 Power Requirements

The MX Series power Source has been designed to operate from a three-phase, three wire (Wye or Delta) AC input line. A protective earth connection is required as well. (PE).

Available three-phase input settings are 208 V_{LL} (option -208), 230 V_{LL} (option -230), 400 V_{LL} (option -400), 440 V_{LL} (option -440), or 480 V_{LL} (option -480).



Figure 3-1: The MX15 Power Source



CAUTION: Do not connect 400, 440, or 480V into a unit set for 208 or 230V unit, the result could be a severely damaged unit. Always check the input rating on the model number tag before connecting AC input power. Consult factory if input settings have to be changed.

3.3 Mechanical Installation

The MX's are completely self-contained power sources. They are to be used free standing on a solid surface. The units are fan cooled, drawing air in from the front and exhausting at the rear. The front and back of each unit must be kept clear of obstruction and a 6" clearance must be maintained to the rear. Special consideration of overall airflow characteristics and the resultant internal heat rise must be considered at all times to avoid self heating and over temperature problems.

3.4 AC Input Connections and Wiring

Three-phase Delta or Y AC input voltage of sufficient amperage (consult AC input specifications for maximum AC current per phase) is required to power the MX Series.

Note: *AC power should be routed through a properly sized and rated three-phase PROTECTIVE CIRCUIT BREAKER or similar branch circuit protection device with disconnect capability. This will protect building wiring and other circuits from possible damage or shutdown in case of a system problem. It will also facilitate removing AC input power to the MX system in case of service or reconfiguration requirements.*

Note: *AC input wiring and connections must conform to local electrical safety codes that apply. Always consult a qualified electrician prior to installation of any MX System.*

AC input connections are to be made directly to the input fuse block. The input fuse block is located on the lower right hand corner of the back of the MX15 chassis. To access the input fuse connection block, the protective rear cover needs to be removed first.



CAUTION: *Always disconnect any input power completely when removing any protective cover and allow the internal capacitors to fully discharge (minimum of 15 mins) before removing any cover. See Figure 3-2 for details.*

No wiring for AC input connections is provided with the MX Series and must be provided by the end user or installer. Input wiring should be entered through the right hand side (when facing the back of the MX cabinet, see Figure 3-4) wire access opening located at the rear bottom of the MX15 chassis.

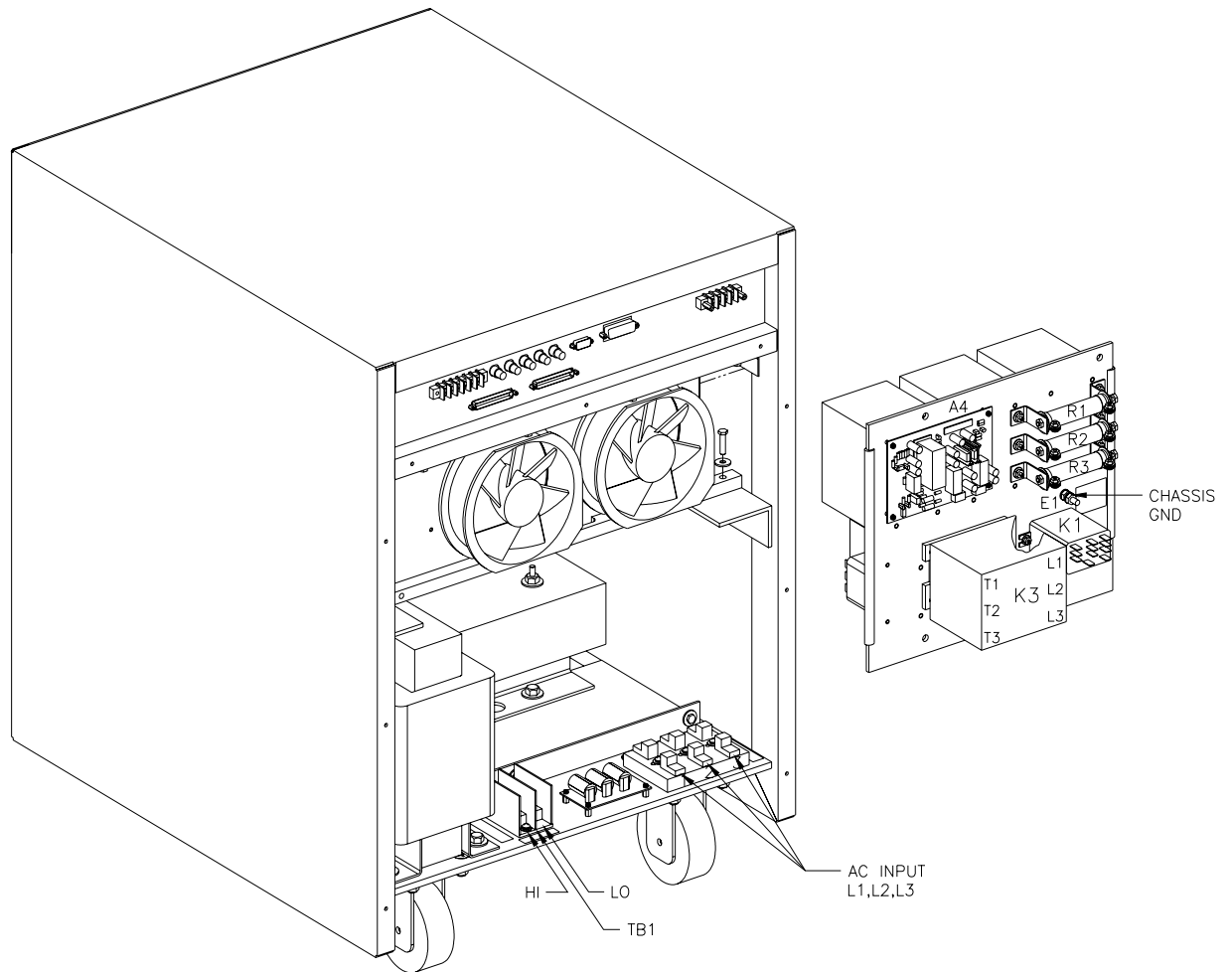

Figure 3-2: Location of AC Input Fuse Block and Chassis Ground Connection - Rear View, Access Panel Removed

Note: To comply with product safety requirements, **EARTH GROUND** must be connected to the chassis of the AC power system using the ground stud located directly below the inrush resistors. Use a Green/Yellow ground wire.

Note: **DO NOT USE THE NEUTRAL CONNECTION OF A 3 PHASE Y AC POWER CONNECTION IN PLACE OF A TRUE EARTH GROUND CONNECTION. AC power system neutrals cannot be used for protective earth ground.**

The mains source must have a current rating equal to or greater than the input fuses and the input wiring must be sized to satisfy the applicable electrical codes. The rear cover must be re-installed prior to use and the strain relief provisions located at the rear bottom of the unit must be used to maintain protection against hazardous conditions.

WARNING:

**DELTA INPUT WIRING CONNECTION ONLY.
NO NEUTRAL CONNECTION IS NEEDED.
DO NOT USE AN AC NEUTRAL CONDUCTOR FOR
GROUNDING THE MX CHASSIS. USE A SEPARATE
PROTECTIVE EARTH GROUND CONNECTION ONLY.**

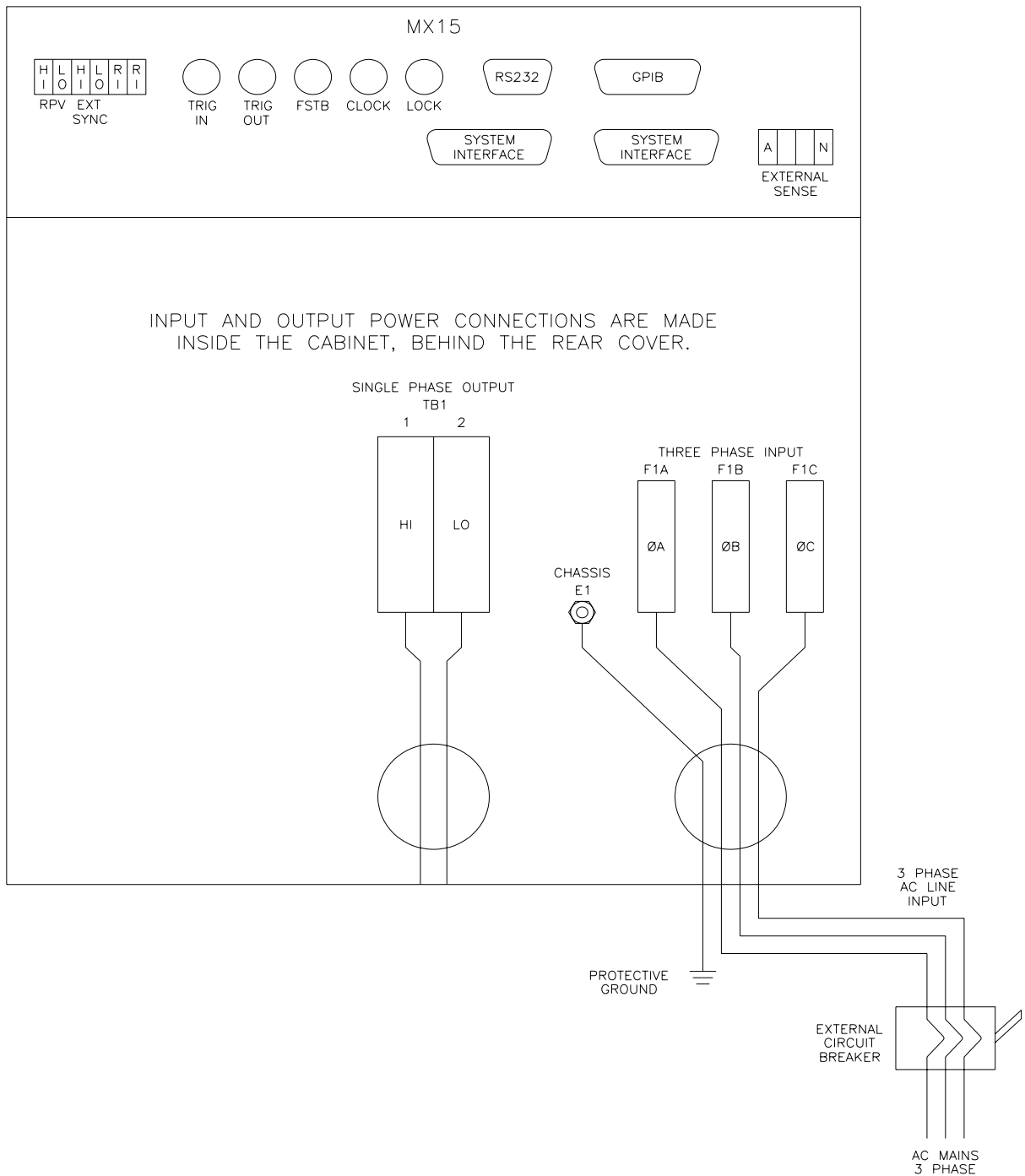

Figure 3-3: MX Series AC Input Connection Diagram (Rear view)

The input power cables and protective circuit breaker used must be large enough to handle the input current and input voltage of the power source and must conform to local electrical codes. Consult a qualified electrician prior to installation. Table 3-1 shows the size of the cables that may be used per MX15 cabinet. Note that wires must be sized to accommodate the worst-case maximum current that may occur under low line conditions. Local electrical codes may also require different wire types and sizes. These ratings should also be used when selecting a circuit breaker or equivalent disconnect device.

Cable lengths must not exceed twenty-five (25) feet. For lengths greater than 25 feet, calculate the voltage drop from the following formula:

$$2 \times \text{DISTANCE} \times \text{CABLE RESISTANCE PER FT.} \times \text{CURRENT} = \text{VOLT DROP}$$

Table 3-1: Suggested Input Wiring Sizes for each MX Cabinet *

Nominal Line Voltage	Load Current @ low line	Wire Gauge (US)	Circular Mils (Kcmils)	Metric (mm2)
480 V	25 Arms	10 AWG	11.50	5.8
400 V	30 Arms	10 AWG	11.50	5.8
230 V	52 Arms	8 AWG	18.00	9.1
208 V	58 Arms	6 AWG	26.24	13.3

* Using high temperature rated wire. Always consult the National Electrical Code and/or local code regulations for proper rating and size of wire cabling prior to installation.



CAUTION: *Capacitors in the power source may hold a hazardous electrical charge even if the power source has been disconnected from the mains supply. Allow capacitors to discharge to a safe voltage before touching exposed pins of mains supply connectors.*

Power modules need at least 15 Minutes to discharge to safe levels before they can be removed.

3.5 AC On/Off Circuit Breaker on MX Series front panel.

It is important to understand the purpose and operation of the On/Off circuit breaker of the MX15 located on the left side of the front panel. This is a 2A rated breaker that is used to engage and protect the LV Power supply of the MX15 chassis only. The LV Power supply provides DC bias power to the entire MX15 system. The AC input power is routed through a set of three AC line fuses (F1, F2 and F3) located in the lower right bottom corner of the MX15. (See Figure 3-2 for fuse locations). These fuses protect the MX amplifier and the AC input transformer from excessive input currents. The AC input power is connected to the input transformer through a large three-pole contactor. Removing AC power to the LV Power Supply by opening the front panel circuit breaker (moving the lever to the down (OFF) position) will cause this contactor to lose its coil voltage and will result in it opening and disconnecting the input transformer and amplifier from AC mains input.

Note: *If any MX15 system failure has occurred on any part of the MX15 system, AC input power must be removed immediately and not restored until the system has been inspected by a qualified service technician. Always turn off the On/Off Circuit breaker before re-applying AC input power.*



CAUTION: The AC input fuses can only be checked if the MX unit is completely de-energized and disconnected from any AC power input.

Note: Under no circumstances should AC input power be applied if one or more of the AC input line fuses have failed and opened up.

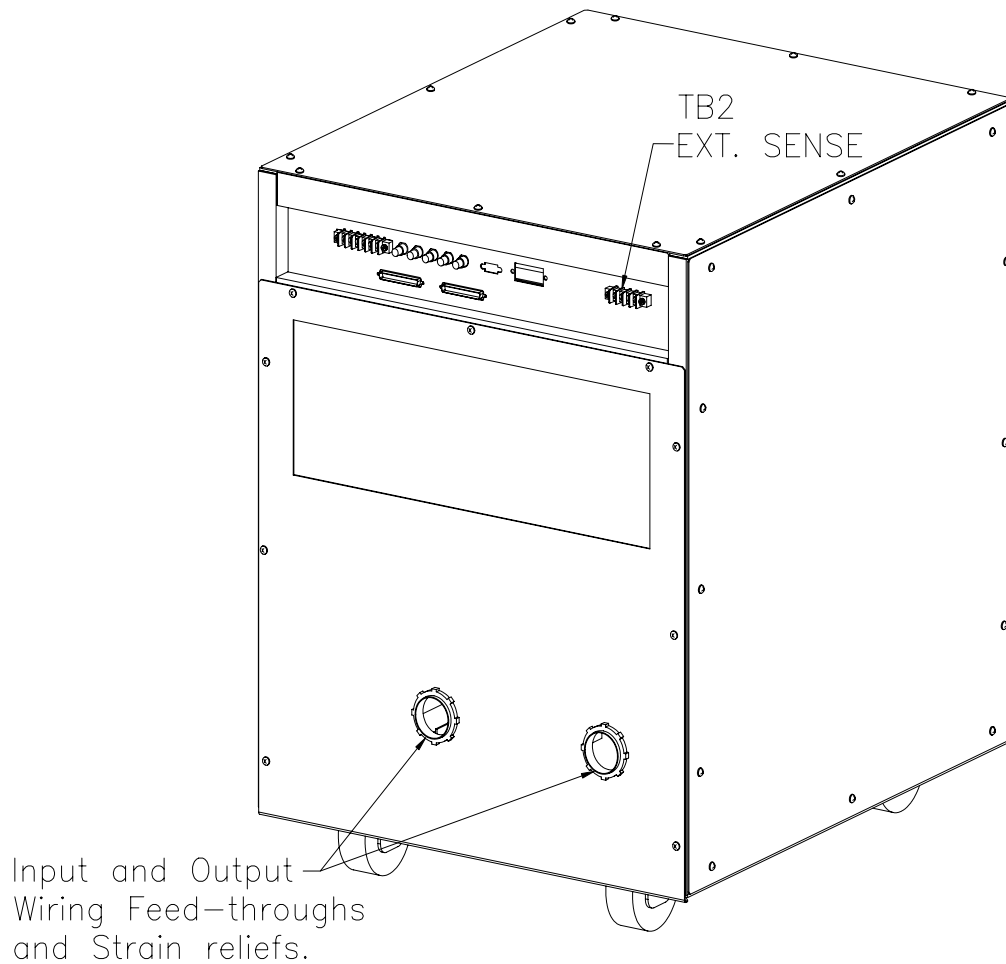

Figure 3-4: Rear Panel

3.6 Output Connections

3.6.1 Output Wiring

The output terminal block, TB1, is located at the back of the unit behind the bottom access panel. See Figure 3-2 for details.

Single phase output line connections are made to terminal block TB1. The outputs are labeled HI and LO.

The external sense inputs allow the power system output voltages to be monitored directly at the load and must be connected at TB2 when the sense is programmed for external. The external sense input does not have to be connected when Internal Sense is programmed. The external sense wires are to be connected to TB2 on the rear panel and should be run using a twisted shielded cable. See Figure 3-4 for location of TB2 and Figure 3-5 for shield connection detail.

Note: *For External Sense connection, a shielded cable MUST be used with the shield connected to chassis ground at the Ext. Sense connector. (See Figure 3-5).*

External sense is recommended for multi-cabinet systems where the output wiring from the cabinets to the common output terminal block supplied is not of equal length.

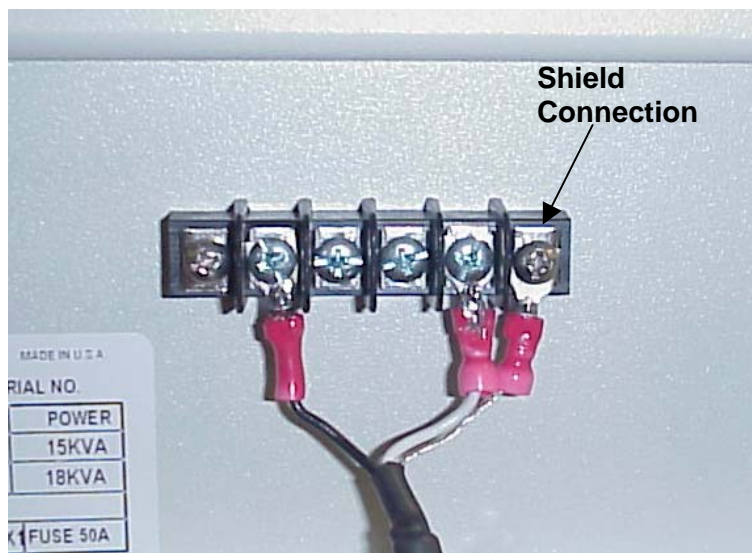

Figure 3-5: External sense cable shield connection to chassis ground

Note: *The output of the power source is isolated from the input line and floating with respect to chassis ground. If needed, either side (HI or LO) may be grounded.*

If the EUT changes frequently, you may want to consider using some quick disconnect scheme external to the MX15 so it will not be necessary to power down the MX15 and remove the front covers. This can take the form of a panel-mounted socket of sufficient current and voltage rating. (Not supplied with MX15)

The output power cables must be large enough to prevent a total voltage drop exceeding 1% of the rated output voltage between the power source and the load. Table 3-2 shows the size of the cables that may be used. Note that wires must be sized to accommodate the maximum current that is available. Size the wires for the lowest available voltage range as the currents will be highest in that range.

Cable lengths must not exceed twenty-five (25) feet. For lengths greater than 25 feet, calculate the voltage drop from the following formula:

$$2 \times \text{DISTANCE} \times \text{CABLE RESISTANCE PER FT.} \times \text{CURRENT} = \text{VOLT DROP}$$

Table 3-2: Suggested Output Wiring Sizes *

Load Current	Wire Gauge (US)	Circular Mils (kcmils)	Metric (mm ²)
65 AMPS	6 AWG	26.24	13.3
130 AMPS	4 AWG	41.74	21.1

Note: Use high temperature rated wire. Always consult the National Electrical Code and/or local code regulations for proper rating and size of wire cabling prior to installation.

Output Terminal Blocks

The MX15-1 and the MX15-1Pi have one output terminal block. The terminal block is large enough to accommodate the recommended wire gauge sizes shown in Table 3-2. The terminal block is located in the lower left corner on the rear of the unit. The rear panel needs to be removed to access this terminal block.



CAUTION: REMOVE ALL INPUT POWER TO THE MX15 BEFORE REMOVING THE REAR PANEL.

The correct standard size Allen wrench for connecting output wiring to TB1 is supplied with each MX15 in the ship kit. Look for a brown envelope. If the correct tools cannot be found, contact California Instruments customer service at support@calinst.com.

Terminal 2 of TB1 provides the output LO connection, and terminal 1 of TB1 provides the output HI connection. The location of TB1 is shown in Figure 3-2.

3.6.2 MX15-1, MX15-1Pi Output Wiring Diagram

Figure 3-6 shows the required output connections for a MX15-1 and MX15-1Pi (rear-view perspective).

Always disconnect all input power from the MX before removing the rear panel cover that provides access to the input and output terminal connections.

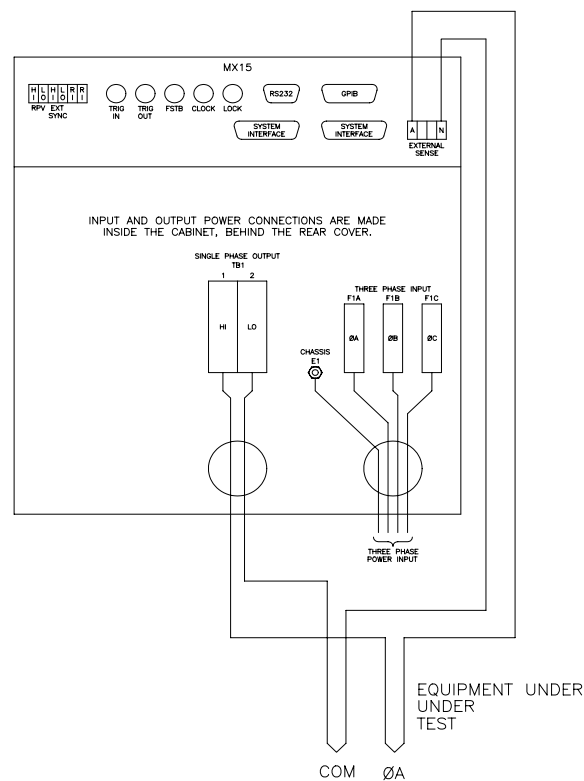

Figure 3-6: MX15-1 Output Wiring (Rear view)

3.6.3 MX30/2 Output Wiring Diagram

Figure 3-7 shows the required output connections for an MX30/2-1 single-phase output configuration (rear-view perspective). Always disconnect all input power from the MX30/2 before removing the rear panel cover that provides access to the input and output terminal connections. MX30/2 systems are shipped with external output terminal blocks that enable the output wiring from two or three chassis to be combined, providing a single point of connection to the EUT. These blocks are not enclosed however.

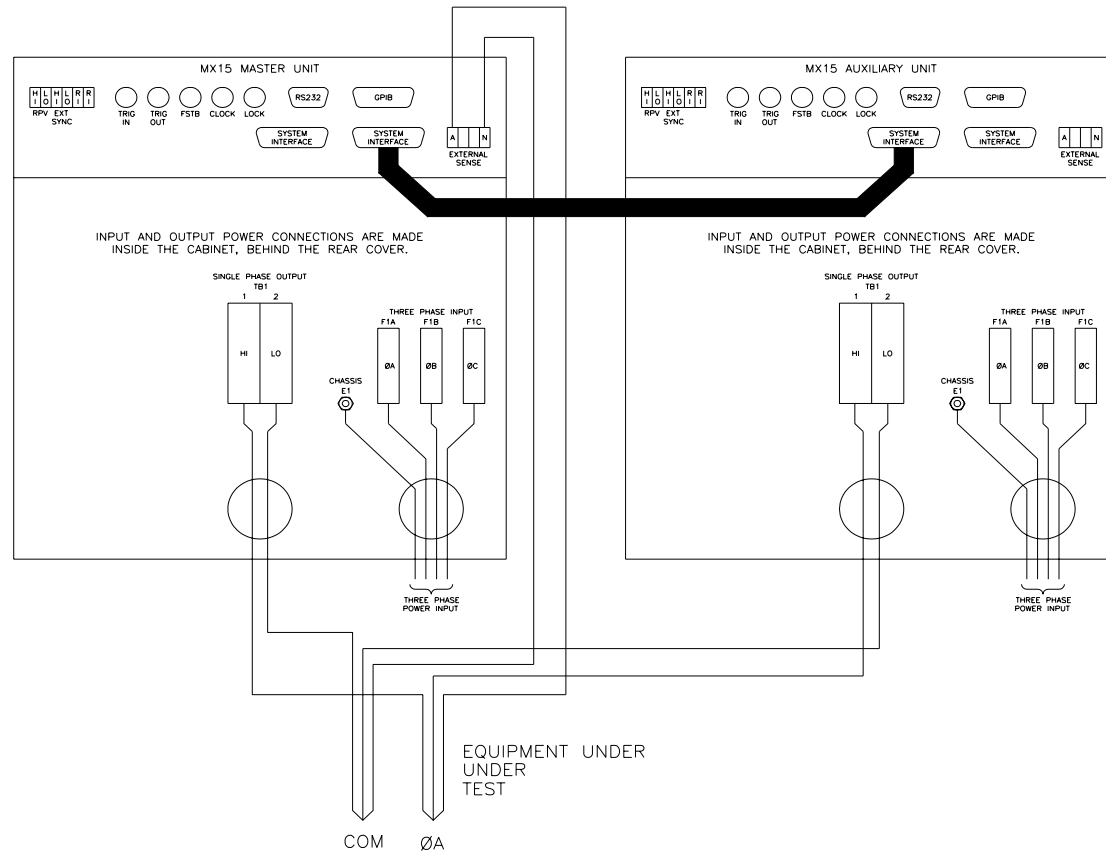

Figure 3-7: MX30/2 or MX30/2-MB Output Wiring (Rear view)

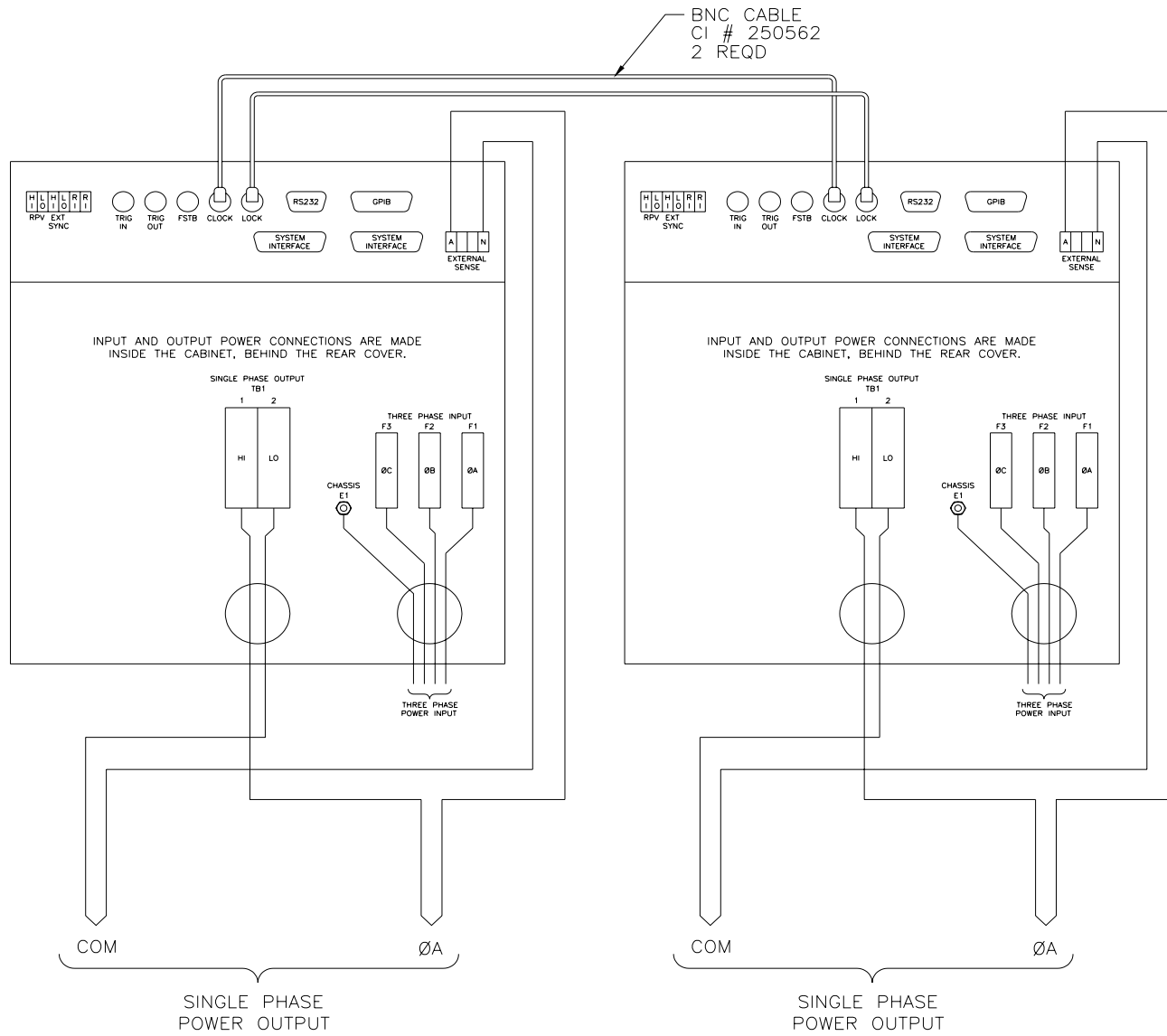

Figure 3-8: Two MX's in Clock and Lock mode Output Wiring (Rear view)

MX135 Output Wiring Diagram

Figure 3-9 shows the required output connections for an MX45/3-1Pi or MX45/3-1Pi-MB single-phase output configuration (rear-view perspective). Always disconnect all input power from the MX45/3 before removing the rear panel cover that provides access to the input and output terminal connections. Note that the master is shown in the center in this drawing. MX45/3 systems are shipped with external output terminal blocks that enable the output wiring from two or three chassis to be combined, providing a single point of connection to the EUT. These blocks are not enclosed however.

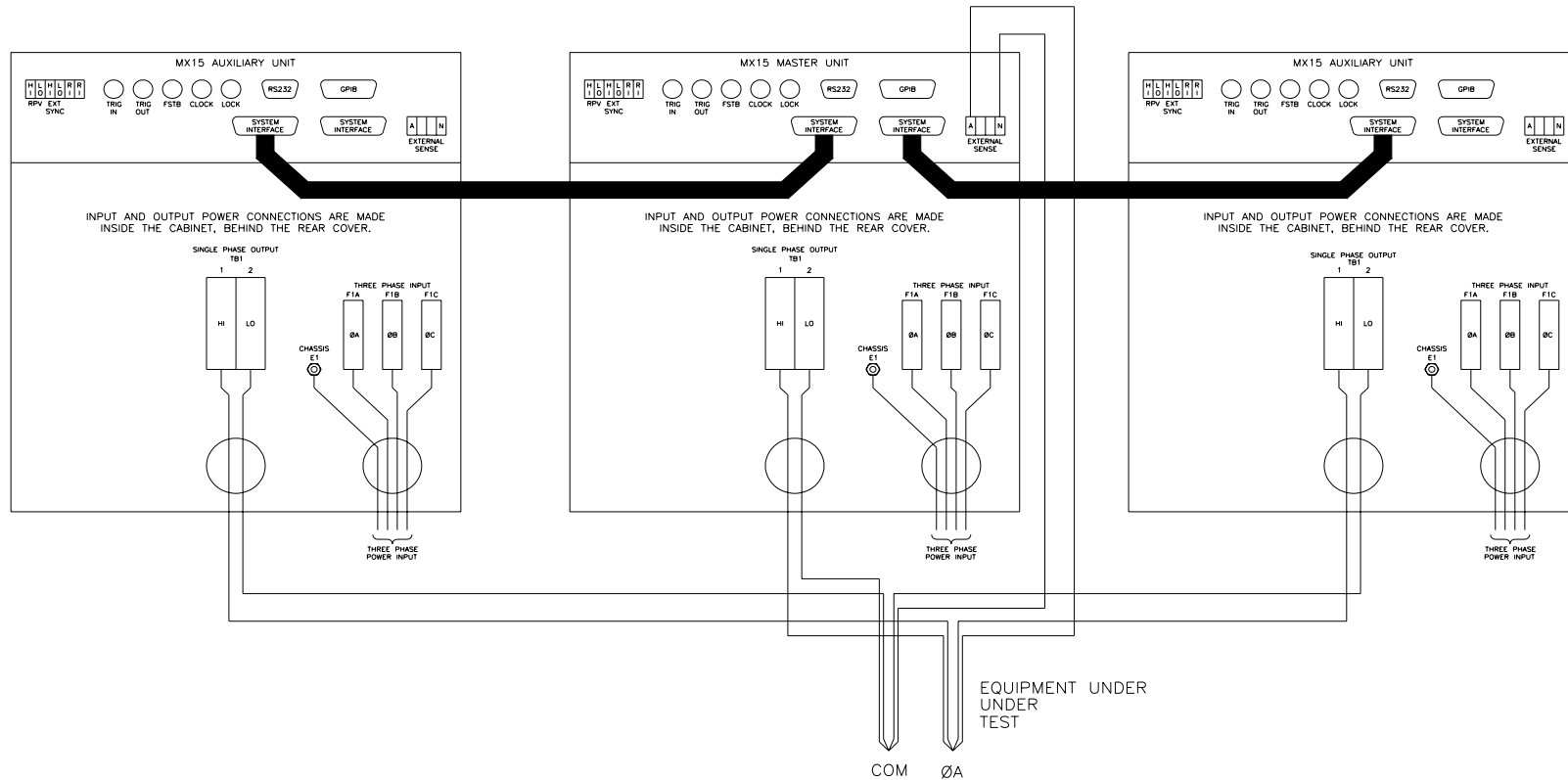

Figure 3-9: MX45/3 or MX45/3-MB Output Wiring (Rear view)

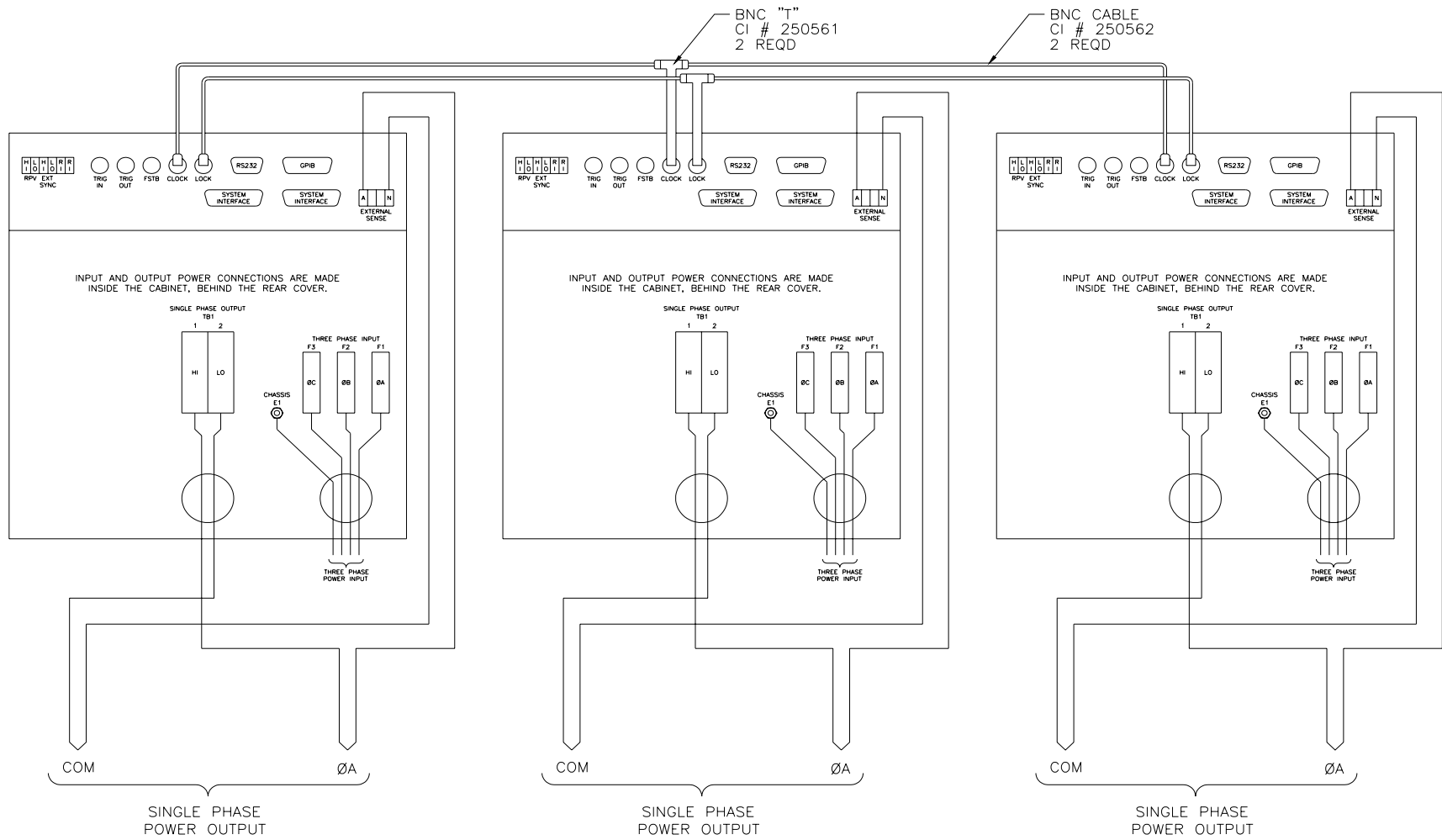

Figure 3-10: Three MX's in Clock and Lock mode - Output Wiring (Rear view)

3.6.4 Multi-Chassis Output Connections

If two or more MX15 chassis are used to form a single power system, the outputs of all chassis need to be combined (paralleled). This can be done directly at the EUT if convenient or using the provided heavy-duty terminal block. One 2-position block is provided. This block allows up to four wires to be combined into one larger wire gauge size wire. The outputs of the 2 or 3 MX15 chassis are connected on one side of these blocks. The EUT can be connected to the other side. Note that the wire size to the EUT should be sized up to accommodate the double or triple currents per phase.

The dimensions of the supplied terminal block are shown in Figure 3-11.

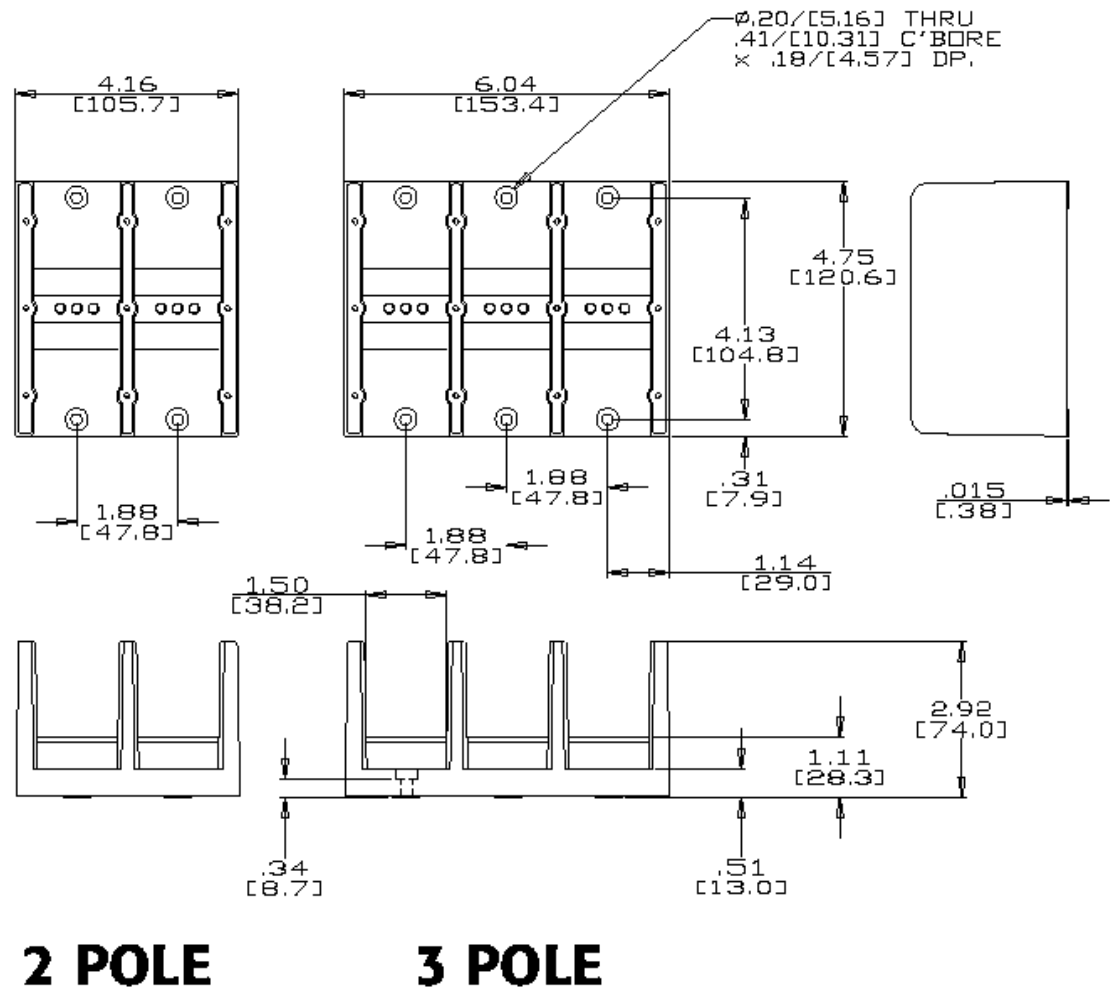

Figure 3-11: Ship kit Terminal Block dimensions

3.7 Connectors - Rear Panel

A number of connectors are located along the top rear covers. These connectors are in a recessed area to protect them from shipment damage.

3.7.1 System Interface



WARNING: The system interface connectors are for use with California Instruments supplied cables, and only between California Instruments equipment.

The Clock and Lock BNC connectors located on the rear panel are used to synchronize and control the phase shift between the three outputs when 3 units are operating as a three-phase clock and lock system. This mode of operation requires the -LKM (on Master unit) and -LKS (on Auxiliary units) options. See paragraph 3.10 for more information on this mode of operation.

A set of two identical System Interface connectors, P8 and P9 is located on the rear panel of each MX15 chassis. The system interface is used to connect the multiple MX15 power sources in a Master/Auxiliary configuration to create MX30/2 or MX45/3 models. In these configurations, only the Master MX15 power source has a built-in controller and front panel.

The same connector is also used to control the optional OMNI-3-75 Reference Impedance.

P8 / P9	Description
1	OUTP: Output ON. Controls state of output relay
2	N/C
3	N/C
4	N/C
5	COM: Common. Signal return.
6	OT: Over temperature. Indicates over temperature condition.
7	N/C
8	CLB: Current Limit B. (Not Used)
9	CSA: Current Sum Phase A
10	CSC: Current Sum Phase C (Not Used)
11	FLT A: Amplifier Fault Phase A
12	FLT C: Amplifier Fault Phase C (Not Used)
13	XFMR: Optional voltage range select. (-HV or -XV option)
14	PARALLEL: Parallel operation control. (Not Used)
15	INPUT ON: Input power status
16	A ERR LO: Error Signal Phase A, low
17	B ERR HI: Error Signal Phase B, high (Not Used)
18	N/C
19	C ERR LO: Error Signal Phase C, Low (Not Used)

P8 / P9	Description
20	300 VRNG: 300 V AC Range Select
21	COM: Common. Signal return.
22	/REM OFF: Remote Off Control not
23	COM: Common. Signal return
24	FLK/BYP: Flicker / Bypass OMNI control
25	/OVL: Overload not
26	CLA: Current Limit A. Programmed current limit reference for phase A
27	CLC: Current Limit C. Programmed current limit reference for phase C (Not Used)
28	CSB: Current Sum Phase B. (Not Used)
29	N/C
30	FLT B: Amplifier Fault Phase B (Not Used)
31	N/C
32	DC: DC mode control
33	INP OFF: Input power control
34	A ERR HI: Error Signal Phase A, high
35	N/C
36	B ERR LO: Error Signal Phase B, low (Not Used)
37	C ERR HI: Error Signal Phase C, high (Not Used)

Table 3-3: System Interface Connectors

3.7.2 Analog Input Connector

Input screw-terminal strip. Functions are called out on rear panel decal. Table shows connections from left to right when standing at the rear of the MX15 cabinet.

Pin	Description
1	RPV HI. INPUT: Analog input for External Modulation
2	RPV Lo. INPUT: return.
3	EXT SYNC HI INPUT: Analog input for external sync mode.
4	EXT SYNC Lo INPUT: return.
5	RI: INPUT: Remote Inhibit. (See paragraph 3.12.)
6	RI: INPUT: return.

Table 3-4: Analog Interface Connector

3.7.3 BNC Connectors

BNC connectors. Functions are called out on rear panel decal. Table shows connections from left to right when standing at the rear of the MX15 cabinet.

BNC	Description
1	Trigger Input (TTL input)
2	Trigger Output (TTL output) (Same signal connection as Function Strobe. Some units may not have this output connected. If you don't get an output trigger on this BNC, use the Function Strobe BNC instead.)
3	Function Strobe (TTL output) (Same signal connection as Trigger Output)
4	Clock (TTL output on Master / TTL input on Auxiliary)
5	Lock (TTL output on Master / TTL input on Auxiliary)

Table 3-5: BNC Connectors

3.7.4 External Sense Connector

Pin	Description
1	Phase A sense
2	N/C
3	N/C
4	Neutral sense

Table 3-6: External Sense Connector

3.7.5 RS232C Serial Interface Connector

An RS232 serial interface connector is located on the rear panel on all models. Note that two versions of the RS232 exist on the MX model series depending on the age of the unit. Older models can be identified by the fact that they will not have a USB interface.

Pin	Name	Direction
1	N/C	
2	TxD	Output
3	RxD	Input
4	N/C	
5	Common	Common
6	N/C	
7	CTS	Input
8	RTS	Output
9	N/C	

Table 3-7: RS232 Connector pin out – MX with RS232 and USB.

Pin	Name	Direction
1	N/C	
2	RxD, Receive data	Output
3	TxD, Transmit data	Input
4	DTR, Data Terminal Ready	DTR, Data Terminal Ready
5	Common	Common
6	N/C	N/C
7	RTS, Request to Send	Output
8	N/C	N/C
9	N/C	N/C

Table 3-8: RS232C Connector pin out – MX with RS232 but no USB

On MX models without a USB interface, a special RS232 cable is required to connect to a PC. With these MX models, a special 13 foot / 4 meter long cable is supplied in the MX Series ship-kit. The wiring diagram for this cable is shown below in case a longer cable has to be constructed. Alternatively, a generic straight thru DB9 male to DB9 female cable can be used to extend the supplied cable.

MX models that have both RS232 and USB interface use a more common straight through DB9 male to DB9 female serial cable, which is supplied in the MX ship kit for these models.

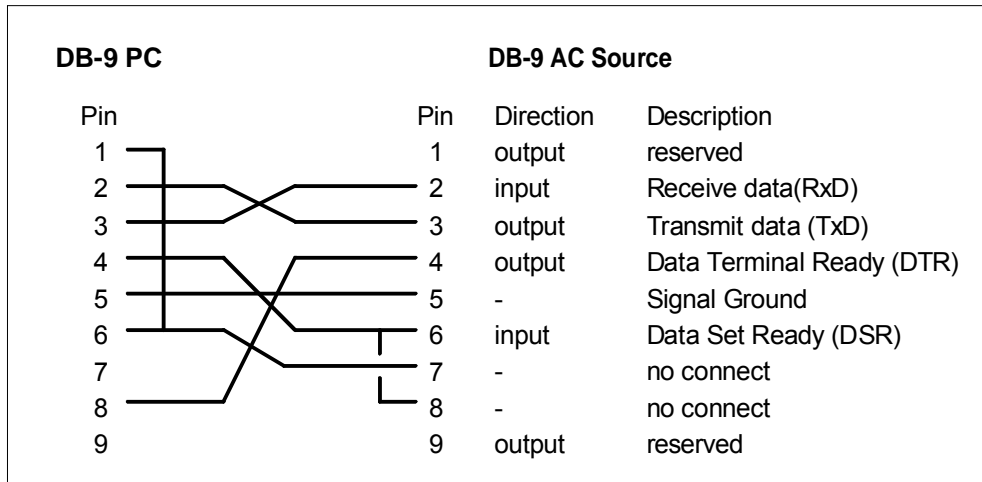

Figure 3-12: RS232C Cable for PC Connection wiring diagram – MX without USB.

3.7.6 USB Interface

A standard USB Series B device connector is located on the rear panel for remote control. A standard USB cable between the AC Source and a PC or USB Hub may be used.



Figure 3-13: USB Connector pin orientation.

Pin	Name	Description
1	VBUS	+5 VDC
2	D-	Data -
3	D+	Data +
4	GND	Ground

Table 3-9: USB Connector pin out.

3.7.7 LAN Interface – RJ45

An optional RJ45 Ethernet 10BaseT connector is located on the rear panel for remote control. A standard RJ45 UTP patch cord between the AC Source and a network Hub may be used to connect the AC source to a LAN. For direct connection to a PC LAN card, a crossover RJ45 cable is required. Consult your network administrator for directions on connecting the AC source to any corporate LAN.

If the –LAN Ethernet interface option is present, the MAC Address (Media Access Control) of the Ethernet port is printed on the serial tag of the power source. The serial tag is located on the rear panel of the unit.

For information on how to set up a network connection or a direct PC connection using the LAN interface, refer to the MX Series Programming Manual P/N 7003-961 distributed in Adobe PDF format on CD ROM CIC496.

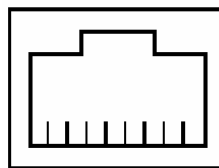

8 7 6 5 4 3 2 1

LAN

Pin	Ethernet TPE 10BaseT/100BaseT/1000BaseT	EIA/TIA 568A	EIA/TIA 568B Crossover
1	Transmit/Receive Data 0 +	White with green stripe	White with orange stripe
2	Transmit/Receive Data 0 -	Green with white stripe or solid green	Orange with white stripe or solid orange
3	Transmit/Receive Data 1 +	White with orange stripe	White with green stripe
4	Transmit/Receive Data 2 +	Blue with white stripe or solid blue	Blue with white stripe or solid blue
5	Transmit/Receive Data 2 -	White with blue stripe	White with blue stripe
6	Transmit/Receive Data 1 -	Orange with white stripe or solid orange	Green with white stripe or solid
7	Transmit/Receive Data 3 +	White with brown stripe or solid brown	White with brown stripe or solid brown
8	Transmit/Receive Data 3 -	Brown with white stripe or solid brown.	Brown with white stripe or solid brown

Table 3-10: RJ45 LAN Connector pin out.

3.8 Multiple Cabinet System Configurations (incl. –MB)

Multi-cabinet MX models consist of two or three autonomous or Auxiliary MX15-1Pi units. Auxiliary units do not have their own controller and are identified easily by their blank front panel. Master units each have their own controller but can be configured as auxiliary units by disconnecting the ribbon cable marked J17 between the controller and the system interface board (P/N 7005-701-1). This disables the controller and allows the MX15 to operate as an Auxiliary unit. (Requires removal of the top cover)

When used as a multi-cabinet system for higher power applications, the controllers in the unit(s) acting as the auxiliary to the master are either disabled or not present.

In addition to disabling the controller if present (as described above), the DIP switch (S1), located on the GPIB / RS232C / IO assembly in the auxiliary cabinets, settings need to be changed. (Requires removal of the top cover). The correct switch settings are shown below. (shown set for Master cabinet). Note that all units must be powered down before reconfiguring. Also, the output wiring must be changed to accommodate the new configuration.

Note: *If the units being re-configured for multi-cabinet operation were not factory configured this way, it may be necessary to balance the amplifiers by adjusting their gain. Refer to section 6.4 for details on Amplifier balancing.*

When used as a multi-cabinet system, the system interface cables must be connected between the master and the auxiliary cabinets.

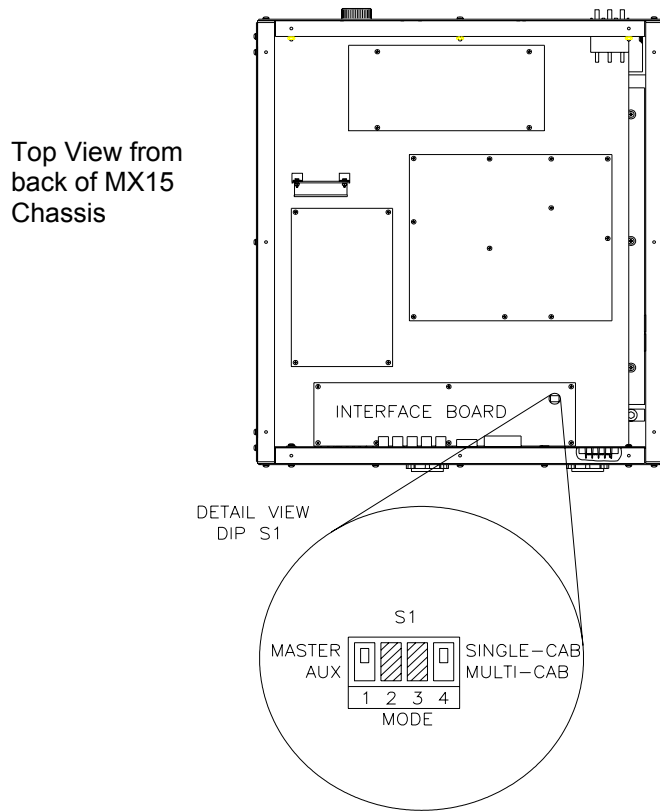

Figure 3-14: Multi-Cabinet DIP Switch Location and Setting

3.9 Multiple Cabinet Power Up/Down Procedures

For all multi-cabinet MX Series configurations (MX30/2, and MX45/3), the following Power Up (Turn on) and Power Down (Turn off) procedures should be observed.

3.9.1 Power Up Procedure

Follow these steps:

1. Turn on each of the Auxiliary units using the front panel circuit breaker, one at a time. The exact order for turning on the auxiliary units is not important. Note that the bias supplies of each of the auxiliary cabinets will power up but not the actual amplifiers. This is because the auxiliary units are waiting for the turn on signal from the master unit.
2. Once all auxiliary units are on, **turn on the MASTER unit LAST** using the front panel circuit breaker. The master unit will go through an initialization process and power up itself plus the auxiliary units.
3. Allow 20 to 30 seconds for the turn on sequence to complete before attempting to communicate with the system.

3.9.2 Power Down Procedure

The power-down / shutdown sequence for the system is the reverse of the power-up / turn-on sequence. This means the MASTER unit is turned off FIRST. Once the MASTER shuts down, all auxiliary units' main AC input power contactors will open up automatically. They still need to be turned off individually using the front panel circuit breaker. This will shut down their bias supplies as well.

Follow these steps:

1. Disconnect the EUT by opening the MX15 output relay. Use the Output On/Off button on the master unit front panel or send the "OUTPUT 0" command over the bus to do so.
2. **Turn off the MASTER unit FIRST** using the front panel circuit breaker. The master unit will disengage the main AC power input contactors of all auxiliary units at this time.
3. Next, turn off each of the Auxiliary units using the front panel circuit breaker, one at a time. The exact order for turning off the auxiliary units is not important.

3.10 Clock and Lock Configurations

The MX15 Series may optionally be equipped for clock and lock mode of operation. This mode is a special form of Master/Auxiliary, which requires each chassis to have its controller. As such, it is possible to create 1, 2, or 3 phase power systems using 2 to 3 MX15 chassis. For most single-phase configurations, the normal multi-box mode of operation as described in section 3.7.5 is recommended as it provides a single controller (and remote control interface).

In a clock and lock configuration, each unit has its own front panel controls (as well as individual remote control interfaces) for operating the supply but the output frequency of the auxiliary unit(s) (-LKS option) is synchronized (locked) to the Master MX unit (-LKM).

This mode of operation requires that one MX15 has the -LKM (Lock Master) option and one or two MX units have the -LKS (Lock auxiliary) option.

3.10.1 Clock/Lock Configuration Settings

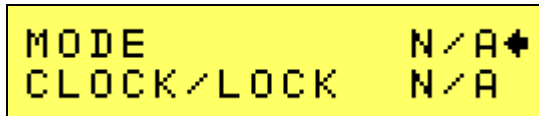

Clock and lock configuration settings for -LKM and -LKS equipped MX15's are set at the factory at the time of shipment and cannot be changed. To check the configuration settings for an MX15, select the OPTIONS screen. In the options screen, the CLOCK/LOCK entry determines if the unit can be set as a Master or Auxiliary as follows:

CONFIGURATION Field	Parameter	Description
CLOCK/LOCK	N/A	Clock and Lock option is disabled
	ON	Clock and Lock option is enabled and can be turned on in the MODE field of the CONTROL menu.

Table 3-11: Clock and Lock Configuration settings

Note that the actual mode of operation of a Clock/Lock MX15-LKS auxiliary unit is determined by the Clock mode set in the CONTROL menu. For clock and lock mode of operation, the CLOCK field is set to EXT.

3.10.2 Clock/Lock Initialization Settings

The mode of operation of the MX15 is determined by the MODE setting in the CONTROL menu. If the clock and lock option is enabled, three choices will be available for this field: STAN, MAST, and AUX. Changing the MODE to either MAST or AUX will cause the power source to power on in clock and lock mode.



Available initial settings and their relationship to the Clock and Lock mode of operation are shown in the table below.

INITIAL SETUP 3 Field	Parameter	Description
CLK/LOC	STAN	Normal stand alone mode of operation. For standard MX15 power source with no clock and lock mode of operation.
	MAST	For master (-LKM) power source in clock and lock mode of operation.
	AUX	For auxiliary (-LKS) power source in clock and lock mode of operation. Powers up with clock mode set to external.

Table 3-12: Clock and Lock Initialization settings

3.10.3 Clock/Lock and External Sync Mode

Note that an MX15-LKS auxiliary unit is factory configured to operate in Clock and Lock mode when EXT clock mode is selected. This means that an MX15-LKS **cannot** be used in normal external sync mode. However, the MX15-LKM master unit can be operated in external sync mode.

Furthermore, since the MX15-LKM master unit is factory set for Master mode of operation, it in turn **cannot** be used as an Auxiliary source in a clock and lock configuration.

Note: When the clock and lock option is enabled, each power source will have all three settings available in the MODE field. The master box must be set to either STAN or MAST and the auxiliary box must be set to either STAN or AUX or the clock and lock feature will not work correctly.

3.10.4 Remote Programming of Clock and Lock systems

Since clock and lock systems have multiple autonomous controllers that are synchronized in frequency, remote programming of these systems requires that the application program deal with all MX controllers. This often precludes the use of RS232C as generally not enough serial ports are available. The use of GPIB instead also offers the advantage of using the Group Execute Trigger (GET) capability to effect output changes on all phases (MX's) simultaneously which is otherwise difficult to do.

To set up a GPIB remote controlled clock and lock systems, the GPIB addresses for the individual MX's must be set to different address values in the CONFIGURATION menu.

Note: *This mode of operation is not supported by the MXGUI Windows software supplied with each MX15 unit.*

3.11 Basic Initial Functional Test



CAUTION: *Work carefully when performing these tests; hazardous voltages are present on the input and output during this test.*

Refer to Figure 3-15 for the required functional test set up. Proceed as follows to perform a basic function check of the power system:

1. Verify the correct AC line input rating on the nameplate of the MX unit(s) and make sure the correct three-phase line voltage is wired to the input of the MX before applying input power.
2. Connect a suitable resistive or other type load to the output of the MX. The load resistance value will depend on the voltage range you plan to check. Make sure the power resistor has sufficient power dissipation capability - up to 15 KW for full load test.
3. Connect an oscilloscope and DMM / voltmeter to the AC source output. Set both for AC mode.
4. If the correct voltage is present, turn on the MX unit(s) by closing the On/Off circuit breaker on the front panel. For multi-cabinet systems, turn on the auxiliary unit first and wait for them to cycle on, then turn on the master unit.
5. Set the output voltage to 0 volt and close the output relay with the OUTPUT ON/OFF button. There should be little or no output although the DMM may show a noise level, especially if the DMM is in auto ranging mode.
6. Move the cursor to the VOLTAGE field in the PROGRAM 1 screen and either use the keyboard to program a small voltage (20 VAC) or slew the voltage up slowly with the knob. Observe the DMM reading. The reading should track the programmed voltage.
7. Also monitor the scope. The output should be a sinusoidal voltage waveform.
8. If the output tracks, increase the voltage until you reach 80 % of the voltage range or more. Check the output voltage reading and waveform.
9. Select the MEASUREMENT screen by pressing the MEAS button. The output voltage, current and power will be displayed.

In the unlikely event the power source does not pass the functional test, refer to the calibration procedure in Section 6 or call California Instrument's customer satisfaction department for further assistance.

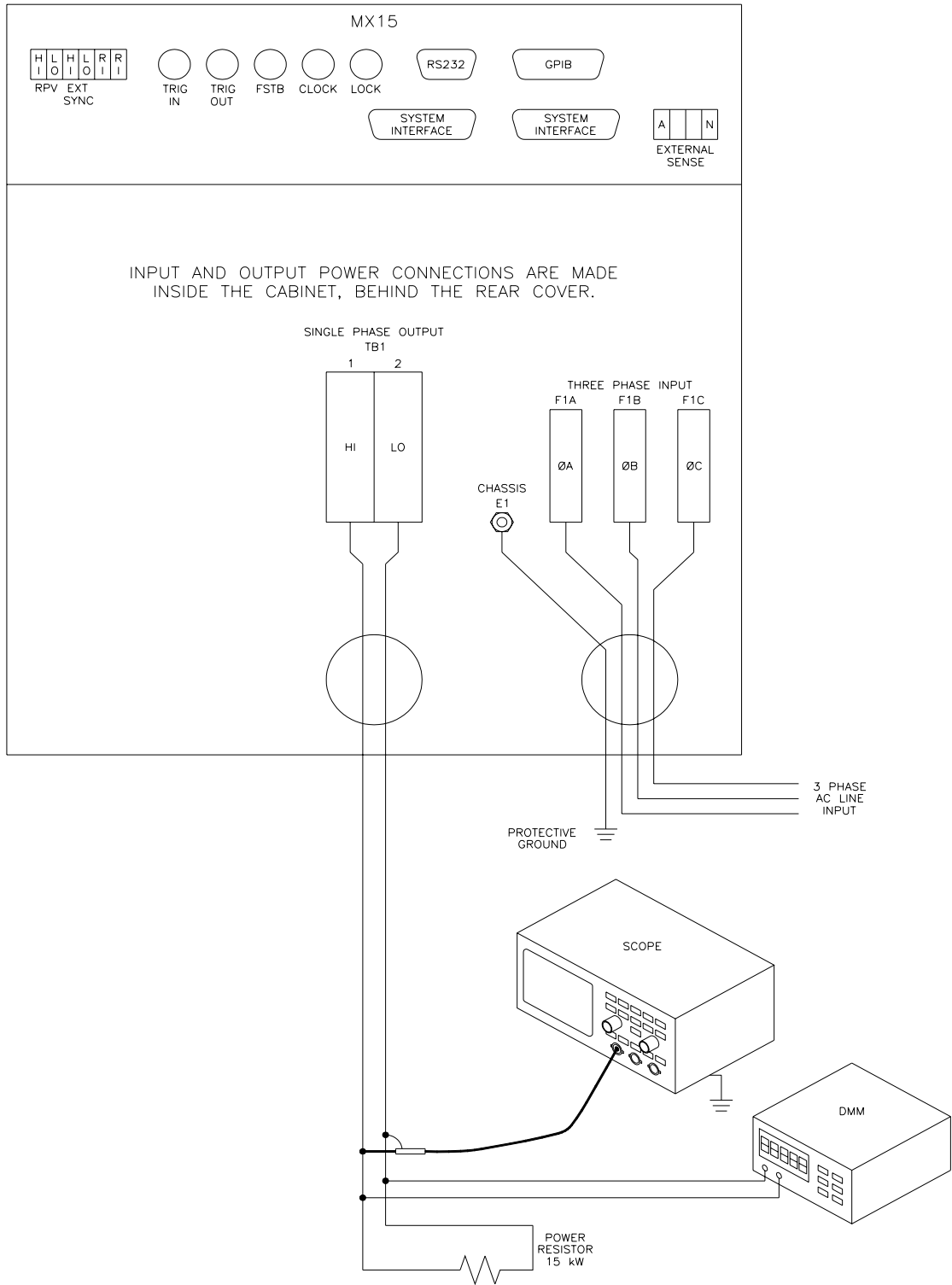

Figure 3-15: Functional Test Setup.

3.12 Remote Inhibit / Remote Shutdown

It may be necessary to provide a remote shutdown of the AC or DC output of the MX. The external remote inhibit input may be used for this purpose (RI). This input is also referred to as remote shutdown.

The default mode of operation for the RI input is a contact closure between pins 5 and 6 (return) of the rear panel screw-terminal strip. This will open the output relay of the MX. The same can be accomplished with an active low TTL input signal.

It is possible to reverse the polarity of the RI input. This requires the use of the following bus command:

```
OUTPut:RI[:LEVel] HIGH      /* Sets RI polarity to active high.
OUTPut:RI[:LEVel] LOW       /* Sets RI polarity to active low (Factory default)
```

Either the RS232, USB, LAN or GPIB interface must be used to perform this setting. Once set, the polarity setting remains in effect.

When set to HIGH, an active low TTL level or a contact closure is required to enable the output relay of the MX. Opening the contact or removing the low input signal will cause the output relay to open.

3.13 Junction Box Accessory

An optional wiring junction box (P/N 7003-416-1) is available which may be used to connect the outputs of 2 to 6 MX cabinets together. The junction box also has a protective ground connection, which **MUST** be connected to a suitable protective earth ground.

Each junction box has four sets of terminals for phase A, phase B, phase C and Neutral. For MX15 application, only phase A and Neutral connections will be made. Each terminal is lined up with a strain relief on each side. The outputs from the MX15 cabinets connect to the “MX SYSTEM OUTPUT” side of these terminal blocks. The load can be connected to the “LOAD” side. Note that the wiring is not supplied with the system and must be provided by the end user. The wire gauge of the load connection must be sized to handle the maximum current in the low voltage range of operation.

The “MX SYSTEM OUTPUT” side of the terminal block will accept up to 8 wires. If the external sense connection is made at the junction box, one of these can be used to connect the sense wiring.

Note: Do not swap output load wires or sense wires between phases, as damage to the system will result.

The “LOAD” side will accept 2 wires. The wire size range shown in Figure 3-16 refers to mechanical compatibility of terminal block only. This information does not reflect required wire size.

The wire sizes accepted by the terminal blocks of the junction box on each side are shown in Figure 3-16.

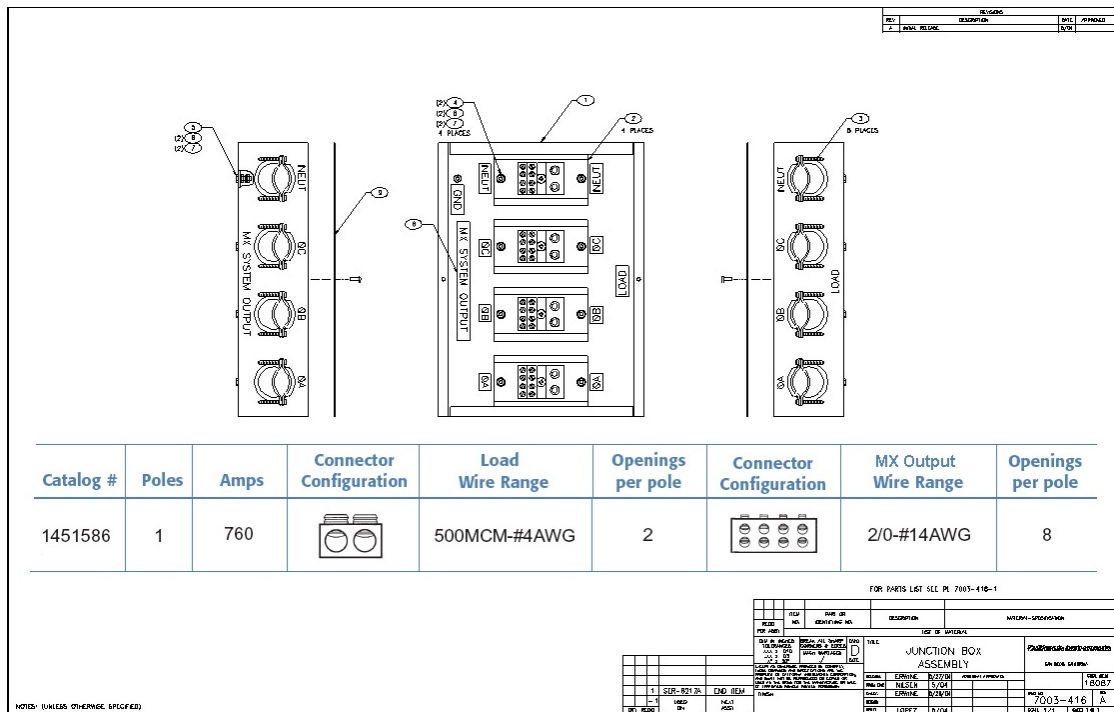

Figure 3-16: 7003-416-1 Output Junction Box

3.14 Output Filter Box Accessory

An optional output filter box (P/N 7003-424-1) is available which may be used reduce the amount of ripple and noise present at the output of the MX15-3Pi.

The filter must be connected between the single-phase output of the MX15 and the unit under test. To access the connection terminal blocks, the top cover of the filter case must be removed.

Note: *Make sure all power is off when connecting the filter accessory.*

The output of the MX15 is connected to the input side of the filter. Use terminal blocks TB1A (phases A and B) and TB1B (phase C and neutral) as indicated in Figure 3-17. For MX15 application, only phase A and Neutral connection will be made. The load can be connected to the load side of the filter box using terminal blocks TB2A and TB2B. Do not swap phases through the filter.

To compensate for voltage drop across the filter, the external sense connections can be made at the load (load side of the filter).

Note: *The filter box chassis must be connected to earth ground.*

It is not recommended to use the ground connection on the MX15 itself for this purpose but rather a ground point at the AC service to the MX15.

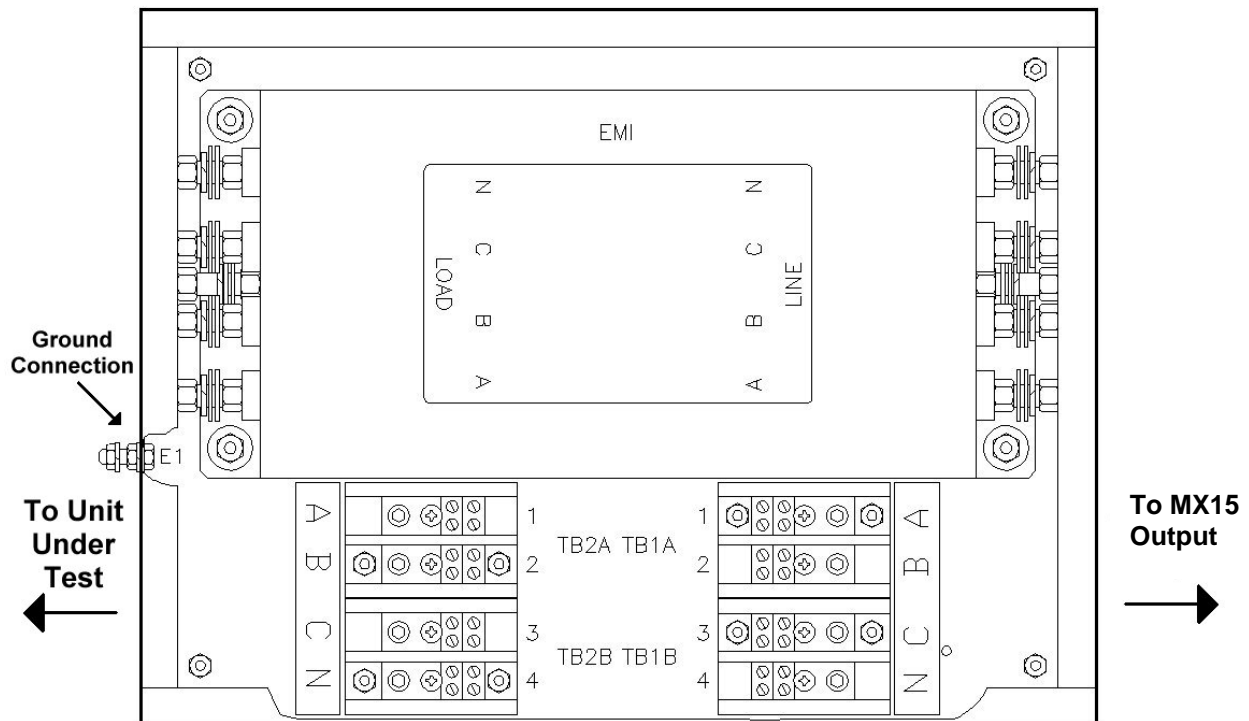

Figure 3-17: 7003-424-1 Output noise filter box.

4 Front Panel Operation

4.1 Tour of the Front Panel

The MX Series with type P or type Pi have identical front panels although some of the keys found on the front panel are only used by MX models with the Pi controller. If your unit is a P type controller, these keys will act as don't cares. This chapter provides information on operating the MX with either controller type.

Before operating the AC source using the front panel, it helps to understand the operation of the front panel controls. Specifically, the operation of the knob, keyboard and the menu layout are covered in the next few paragraphs.

4.1.1 Front Panel Controls and Indicators

The front panel can be divided in a small number of functional areas:

- Mains circuit breaker
- Status Indicator lights
- Shuttle knob
- LCD display
- FUNCTION keypad
- DATA ENTRY keypad

4.1.2 System On/Off Circuit Breaker

The circuit breaker located on the left side of the front panel disconnects the low voltage supply of the MX Source from the three phase Line input. This will remove power from the mains AC input contactor and thus remove input power from the MX Series power source. As such, the circuit breaker acts as an indirect power on/off switch for the MX Series unit. Note however that an AC input power remains applied to the primary side of the input transformer.

When the input current rating of the MX Series AC power source is exceeded, the protective fuses (XF1 through XF3) will blow. In this case, power to the low voltage supply may still remain through the front panel circuit breaker. In this case, the on/off circuit breaker should be opened (power off) first followed by a complete disconnect of all ac input power through an installed main circuit breaker.

Note that in MX30/2 and MX45/3 systems, each unit has its own on/off circuit breaker and set of line input fuses.

4.1.3 Status Indicator Lights

Five LED status indicators are located to the left of the LCD display. These LED's correspond to the following conditions:

REMOTE	The REMOTE LED indicates that the unit is in remote control mode. If the IEEE-488 interface is used, this indicator will be lit whenever the REM line (REMOTE ENABLE) line is asserted by the IEEE controller. If the RS232, USB or LAN interface is used, the REMOTE state can be enabled by the controller using the SYST:REM command. Any time the REMOTE LED is lit, the front panel of the MX Series unit is disabled. The BACK key doubles as a LOCAL button that allows the user to regain control of the front panel.
OVERLOAD	The OVERLOAD LED indicates an output overload condition. This condition can be controlled by setting the current limit value in the PROGRAM menu. Removing the load using the OUTPUT ON/OFF button will recover from an overload condition.
OVER TEMPERATURE	The OVER TEMPERATURE LED indicates an overheating problem inside the unit. This is an abnormal condition, which will cause the unit to shut off. Check the air openings to make sure they are not blocked.
HI RANGE	The HI RANGE LED is on when the high voltage output range has been selected.
OUTPUT	The OUTPUT LED is on when the output relay is closed.

4.1.4 The Shuttle Knob

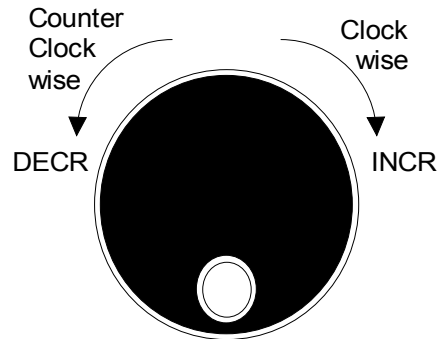

Figure 4-1: Shuttle Knob

The shuttle knob is located to the right of the keypad and is used to change setup parameters. Note that it cannot be used to move the cursor position between menu fields. Use the UP and DOWN arrow keys in the FUNCTION keypad for this.

The shuttle knob can operate in one of two distinct modes of operation:

MODE	DESCRIPTION
IMMEDIATE mode	Any time the ENTER key is pressed, the MX Series returns to its normal mode of operation. In this mode, changes made with the shuttle knob or the data entry keypad will take immediate effect. The IMMEDIATE mode is useful for slewing output values such as voltage and frequency and observing the effect on the load.
SET mode	When the SET key located in the FUNCTION keypad is pressed, changes made with the shuttle to any output parameter will not take effect until the ENTER key is pressed. In this mode, any changes made to a setup menu will be blinking to indicate the pending change condition. This mode allows changes to be made to all output parameters and executing them all at once by pressing the ENTER key.

4.1.5 FUNCTION Keypad

The function keypad provides access to all menus and measurement screens. The following keys are located in the FUNCTION keypad:



Figure 4-2: FUNCTION Keypad

KEY	DESCRIPTION
ON/OFF	The ON/OFF key may be used to control the state of the output relay. The active state is indicated by the Output LED. If the output relays are open (LED is off), the output is floating.
PHASE	The PHASE key has no function and is a don't care.
SET	The SET key selects the PROGRAM setting screen. While this screen is displayed, the rotary knob can be used to change either voltage or frequency. Additional output settings such as current limit can be reached by using the down ▼ cursor key. If the PROGRAM screen is already displayed, the SET key puts the unit in SET mode. For test options such as –704 or –160, the SET key can be used to skip to the next test in a test sequence during test execution.
MEAS	The MEAS key selects the measurement screen. There are no user changeable fields in the measurement screen. The rotary knob is active while the measurement screen is displayed. Additional measurement data can be displayed by using the up ▲ and down ▼ cursor keys.
MENU	The top-level menu is accessed by pressing the MENU key. Refer to section 4.2 for details on available menus. If a menu screen is already displayed, the MENU key will advance to the next menu.
BACK	<p>The BACK key may be used to back up to the previous menu level or previously selected screen. It can also be used as a backspace key to delete the last digit entered.</p> <p>For tests options such as the –160 and –704 options, the BACK key can be used to abort a test in progress.</p> <p>If the unit is in remote mode, (Remote LED is lit), the front panel of the power source is disabled. The BACK button doubles as a GOTO LOCAL button (LOCAL) while the unit is in remote state. This allows the user to regain control of the front panel. This LOCAL button can be disabled by sending a Local Lockout bus command. This prevents unauthorized changes of settings in ATE applications.</p>

4.1.6 Cursor and Enter Keys

The cursor keys are located on the right hand side of the numeric keypad and can be used to scroll through a list of menu entries:

CURSOR UP (▲)	The UP key moves the cursor position upwards one position to the previous available cursor position.
CURSOR DOWN (▼)	The DOWN key moves the cursor position downwards one position to the next available cursor position.
ENTER	The blue Enter key is used to confirm selections made in menus or to active settings made in SET mode.

4.1.7 LCD Display

The LCD display of the power source provides information on instrument settings and also guides the user through the various menus. A sample of the measurement display screen is shown in Figure 4-3.

Menus are accessed by scrolling through two or more entries. Alternatively, the Menu key may be pressed repeatedly to access additional available menu entries.

The active cursor position is indicated by a LEFT POINTING ARROW (←) and can be moved by using the UP (▲) and DOWN (▼) keys located on the right hand side of the numeric keypad.



Figure 4-3: Measurement Screen

4.2 Menu Structure

The next few pages show a map of the available menus in the MX15 Series. All menus can be reached by repeatedly pressing the **MENU** key. Frequently used menus have a short cut key that provides direct access. Examples of such menus are Program and Measurements. In any case, there are never more than two levels of menus although some menus may be spread across more than one screen.

4.2.1 Power on screens

At initial power up, the MX15 Series power supply will display important configuration information in a series of power on screens. These displays are only visible for a short period of time and will not re-appear until the next time the unit is turned on.

There are four screens that will appear in the same order:

1. LANetwork detection... At power up, the unit will try to detect a LAN interface. If not found, a "LAN not available" message will appear. The LAN will not be detected if:
 1. No –LAN option is installed.
 2. The USB port is connected to a computer.
 3. The RS232 port jumper is installed.This process may take several seconds.

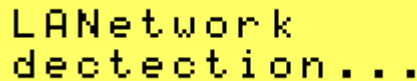

```
LANetwork  
detection...
```

2. Initialization in progress. This means the firmware has started to load.

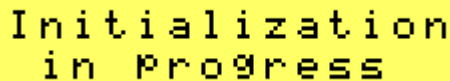

```
Initialization  
in Progress
```

3. Company and firmware information. Displays the manufacturer - Cal Inst., which is short for California Instruments - and the firmware part number and revision. The firmware part number starts with CIC followed by a three-digit code and dash number. The firmware revision has a major revision before the decimal point and a minor revision after the decimal point.

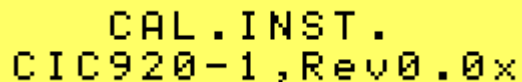

```
CAL.INST.  
CIC920-1,Rev0.0x
```

4. Model and Serial number information. The model will be a function of the configuration and will include the series designation (MX). The serial number is a 5-digit number. This number should match the model type sticker located on the back of the unit.

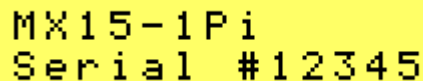

```
MX15-1Pi  
Serial #12345
```

5. Memory test result. If all memory tests pass at power on, the message "Self test passed" will appear. If not, an error message will be displayed instead. This information may be useful when calling in for service support.



MEMORY TEST
PASSED

Once the power on sequence is completed, the power source will always revert to the PROGRAM screen shown here. The power source is now ready to be used.



VOLT 0.00 ✦
FREQ 60.00Hz

4.2.2 Top Level Menus

The following top-level menu choices can be accessed using the **Menu** key:

ENTRY	DESCRIPTION
PROGRAM	The PROGRAM menu allows primary output parameters such as voltage, frequency, current limit, waveform shape and voltage range to be changed.
CONTROL	The CONTROL menu allows secondary setting parameters such as sense mode, phase mode and ALC mode to be changed.
MEASUREMENTS	The MEASUREMENT screen is not a menu in that no user entries are required. It displays read-back data.
TRANSIENTS	The TRANSIENTS menu allows output transients to be programmed.
REGISTERS	The SETUP REGISTERS menu allows complete instrument settings and transient list programs to be saved to nonvolatile memory.
CONFIGURATION	The CONFIGURATION menu allows changes to be made to configuration settings such as the IEEE-488 address, RS232C internal baud rate, and power on state.
OUTPUT CAL	The OUTPUT CAL menu provides access to the LCD viewing angle and Calibration password entry. If the correct calibration password is entered, additional calibration screens can be accessed.
MEAS CAL	The MEAS CAL menu allows for calibration of the AC source measurement system.
APPLICATIONS	The APPLICATIONS menu provides access to the optional firmware application programs that may be installed in the power source controller.
OPTIONS	The OPTIONS menu provides access to optional functions that may be present on the power source.

ETIME/TEMP	The ETIME/TEMP screen displays the Elapsed time (Time the unit has been in operation) in hours, minutes and seconds. It also displays the internal temperature of the unit in degrees Celsius.
LIMITS	The LIMITS screen displays the hardware configuration limits of the AC power source. It is for display purposes only and the user can change none of these fields.

4.2.3 Menu Tree

MX15 Series

Menu Structure

LEVEL 1

PROGRAM
CONTROL

LEVEL 2

VOLT 120.0V
FREQ 400.0HZ

VRANGE 150.0V
PHASE 0.0°

FUNC >SINUSOID
CLIP THD 10.0

VOLT MODE AC
DC OFFSET N/A

CURR 125.00A
OL MODE CV

SENSE INT
SYNC INT

CLOCK INT
MODE STAN

ALC STATE ON
IMP STATE OFF

IMP RES 0mΩ
IND 0mH

OUTPUTS N/A
ST PHASE RAND

MEASUREMENT
TRANSIENT

100.00V 49.04A
400.0HZ 4.9KW

4.9KVA 1.00pF
49.04A 0.98cF

0.18%A 0.05A
0.19%V 0.0°

TRAN ST IDLE
COUNT 10

LEVEL 1

REGISTERS
CONFIGURATION

LEVEL 2

SAVE REG #
RECALL REG #

ADDRESS 1
BAUD RATE 38400

PON STATE RST
LANetwork <

OUTP CAL
MEAS CAL

VIEW ANGLE 0
CAL PWORD 0

VOLT FS 17251
VOLT ZERO -91

IMP REAL FS 0
IMP REAC FS 0

IMP REAL0in
IMP REAC0in

PHASE OFST 0.0

VIEW ANGLE 0
CAL PWORD 0

MVOLT FS -1000
MCURR FS -3000

APPLICATIONS
OPTIONS

MIL704
DO160

MS704

SYSTEM MX15-1Pi
ADVANCE ON

MODE N/A
CLOCK/LOC N/A

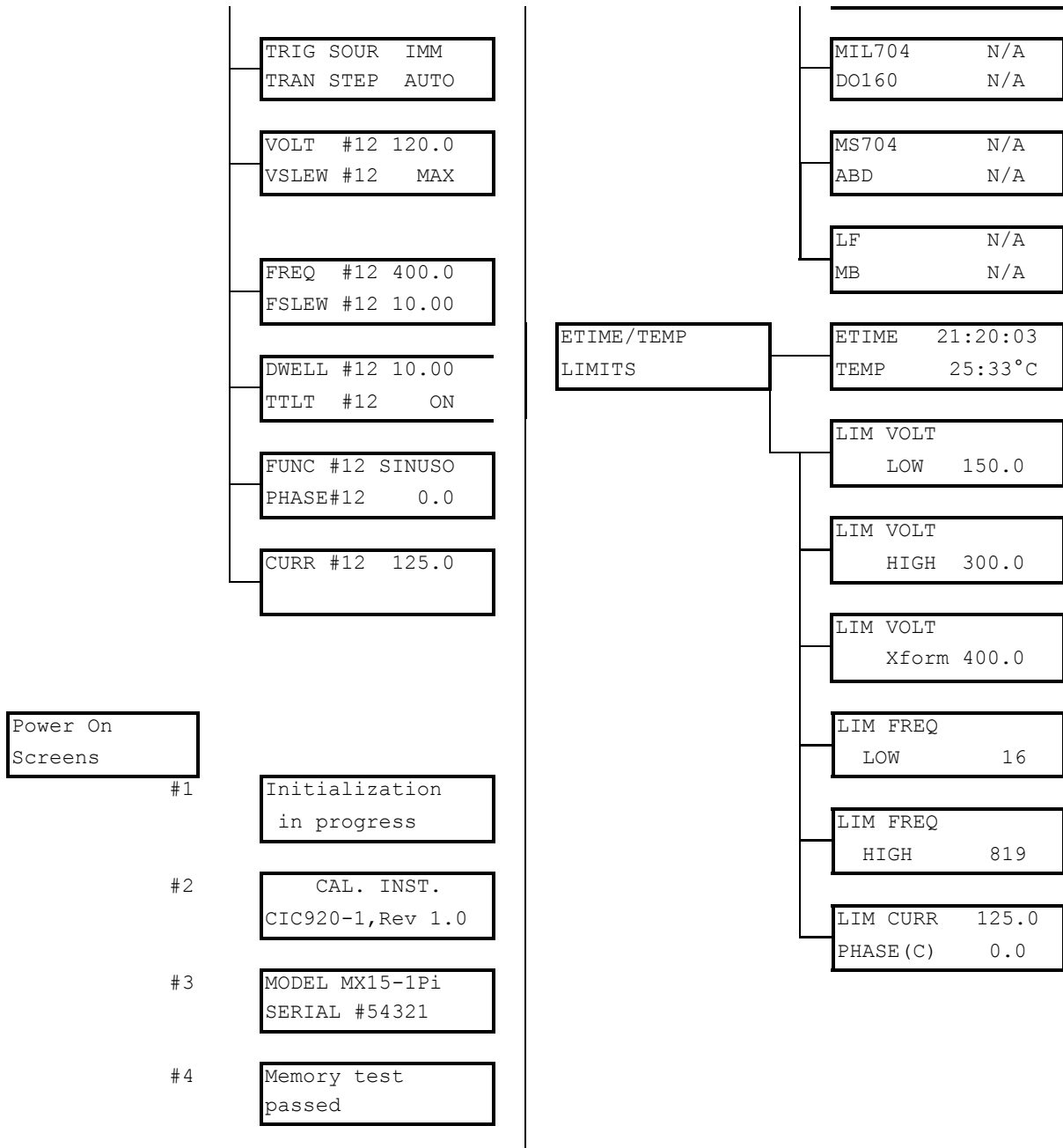
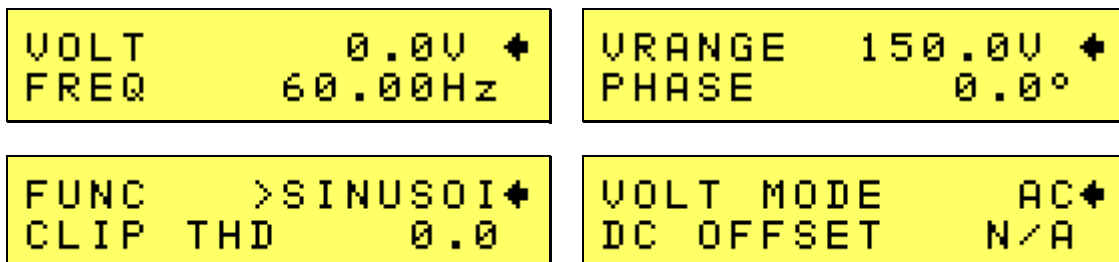
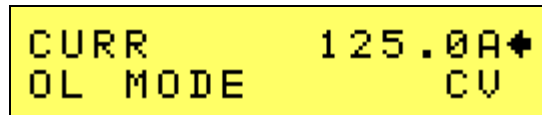

Table 4-1: Menu Tree

4.2.4 PROGRAM Menus





CURR 125.0A
OL MODE CU

Figure 4-4: PROGRAM Menu

The PROGRAM menu is shown in Figure 4-4. It can be reached in one of two ways:

1. By selecting the **MENU** key, selecting the PROGRAM entry and pressing the **Enter** key.
2. By pressing the **SET** key.

The PROGRAM menu is used to change primary output parameters. Less frequently used parameters are located in the CONTROL menu.

The following choices are available in the PROGRAM menus:

ENTRY	DESCRIPTION
VOLT	Programs the output voltage in Vrms. The voltage can be changed from 0 to its max range value as determined by the configuration settings and the selected voltage range by using the keypad + Enter or the shuttle (if the voltage field is selected).
FREQ	Programs the output frequency. The frequency can be changed from its min to its max value as determined by the configuration settings by using the keypad + Enter or the shuttle (if the frequency field is selected).
VRANGE	Selects 150V, 300V, or 400V voltage range (if available). The value of this field can be changed with the shuttle as long as the active pointer (←) points to the VRANGE entry.
PHASE	Selects the phase angle between the external clock and the output of the AC source. If the clock source is internal, this parameter has no effect.
FUNC	Selects the waveform for the selected phase. On MX15-1Pi models, available choices are SINUSOID, SQUARE and CLIPPED or any user defined waveform that was downloaded to the AC source waveform memory using the RS232 or IEEE-488 interface. This field is fixed to SINUSOID on MX15-1 models.
CLIP LEVEL	Sets the clip level for the CLIPPED sine wave in percent VTHD. The range is 0 to 20 %. (MX15-1Pi models only). Note: Changing the clip level setting will result in temporary loss of the output voltage as the new clipped waveform is loaded. This may cause the EUT to reset or turn off. To avoid this, set the desired clip level before programming the AC voltage and turning on the output to the EUT or use the transient list system to switch between waveforms.
VOLT MODE	Selects the available output modes of operation. Available modes are AC, DC (all models) and ACDC (Pi models only).

ENTRY	DESCRIPTION
	The shuttle can be used to select the desired output mode.
DC OFFSET	<p>This parameter applies only when the power source is in ACDC mode. The DC offset can only be set to a max value of 220VDC. The rms level of the AC+DC waveform may not exceed the limit of the voltage range (150V or 300V).</p> <p>Note: <i>Changing the offset percentage setting will result in temporary loss of the output voltage as the new offset is loaded. This may cause the EUT to reset or turn off. To avoid this, set the desired offset percentage before programming the AC voltage and turning on the output to the EUT.</i></p>
CURR	Sets the current limit value for the current detection system. When the load current value exceeds the set current limit, a fault condition is generated. The actual response of the AC Source to a current limit fault is determined by the protection mode selected in the OL MODE field. (CC = Constant Current, CV = Constant Voltage).
OL MODE	Sets the current limit overload mode. The actual response of the AC Source to a current limit fault is determined by this setting. Available settings are CC for Constant Current mode or CV for Constant Voltage mode. In CV mode, the AC source output will trip off and stay off until re-engaged. In CC mode, the voltage will be reduced until the current limit is no longer exceeded.

4.2.5 CONTROL Menus

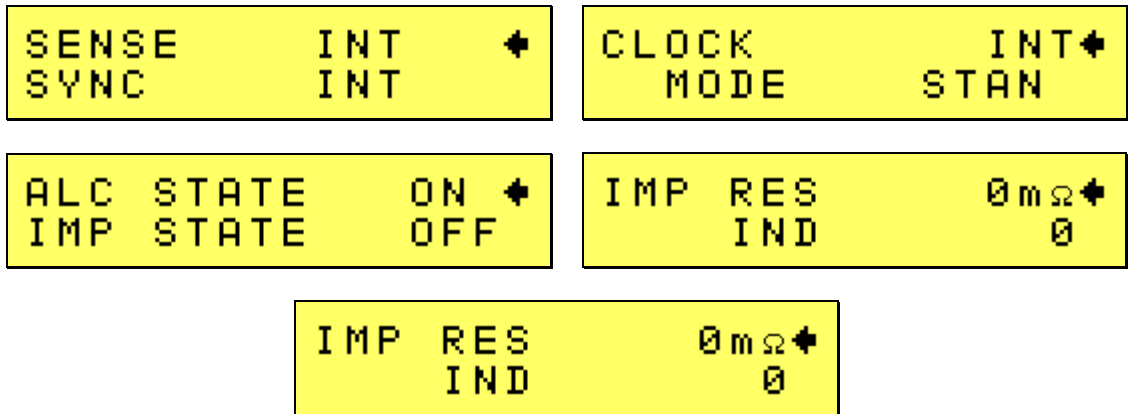

Figure 4-5: CONTROL Menus

The CONTROL menu is shown in Figure 4-5 and can be reached by selecting the **Menu** key, selecting the CONTROL entry using the DOWN cursor key and then pressing the **Enter** key.

The CONTROL menu is used to change secondary output parameters. The following choices are available in the CONTROL menus:

ENTRY	DESCRIPTION				
SENSE	Selects internal or external (remote) voltage sense mode. If INT is selected, the voltage is sensed at the output terminal block. If EXT is selected, the voltage is sensed at the external sense connector. If external sense is selected, care must be taken to connect the external sense lines at the load. For sense leads longer than 1 meter, twisted pairs should be used.				
SYNC	Selects the external sync mode if available. Default is internal sync, which means a free running time base. The time base can be synchronized to an external sync signal by selecting external sync mode.				
CLOCK	Selects internal or external clock source. The MX Series controller uses an open-air crystal time base with an accuracy of 100 ppm. The external clock mode is used to support the –LKS option. For use as an auxiliary unit in a clock and lock system, this field must be set to EXT. A unit with –LKS option can be used stand-alone if needed by setting the INT clock mode.				
	<table border="1"> <tr> <td>INT</td> <td>Default, internal clock.</td> </tr> <tr> <td>EXT</td> <td>Auxiliary unit (-LKS) driven by master (-LKM) clock input. Note: When selecting EXT mode, make sure the Clock and Lock BNC cables are connected to the Master (-LKM) unit. If not, there will be no output on the –LKS unit. See section 3.10 for connection information.</td> </tr> </table>	INT	Default, internal clock.	EXT	Auxiliary unit (-LKS) driven by master (-LKM) clock input. Note: When selecting EXT mode, make sure the Clock and Lock BNC cables are connected to the Master (-LKM) unit. If not, there will be no output on the –LKS unit. See section 3.10 for connection information.
INT	Default, internal clock.				
EXT	Auxiliary unit (-LKS) driven by master (-LKM) clock input. Note: When selecting EXT mode, make sure the Clock and Lock BNC cables are connected to the Master (-LKM) unit. If not, there will be no output on the –LKS unit. See section 3.10 for connection information.				

ENTRY	DESCRIPTION	
MODE	Power on clock mode. The following two modes can be selected.	
	STAN	Power up in INT (internal) clock mode for stand-alone operation. This is the only mode for models without the –LKS option. For units with the –LKM option installed, this field is fixed to CLK/LOCK. For units with the –LKS option installed, this field can be changed to CLK/LOCK for use as an auxiliary unit in a clock and lock system or to STAND for use as a stand alone unit.
	CLK/LOCK	Fixed on master (-LKM) unit configuration in a clock and lock system. Power up with EXT (external) clock mode on unit with –LKS option. (See OPTION menu section.) Note that this field cannot be changed if the –LKM option is installed. The frequency resolution below 81.9 Hz in MAST clock and lock mode is reduced to 0.1 Hz from the normal 0.01 Hz.
ALC STATE	<p>Sets the Auto Level Control (ALC) mode. This mode uses the internal measurement system to zero regulate the output. There are three modes of operation:</p> <p>OFF No measurement based output regulation.</p> <p>REG Output regulation is enabled. AC source will continuously regulate output but will not trip off output.</p> <p>ON Output regulation is enabled and output will fault (trip off) with Error 801 “Output Voltage fault” if regulation cannot be maintained and the programmed output voltage is 10Vrms or higher. No error is generated for settings below 10 volt.</p> <p>In most situations, the ALC mode should be set to REG or ON for optimal performance.</p> <p>Note: The ALC mode only functions for programmed output voltages above 10 Vrms.</p>	
IMP STATE	Selects programmable output impedance. The ALC mode must be turned off for the programmable impedance to be turned on. This function allows you to change the output impedance (R and/or L) of the power source.	
# OUTPUTS	Selects SINGLE or THREE phase mode of operation. The MX15 models operate only in single-phase mode so this field will always show N/A (not applicable).	

ENTRY	DESCRIPTION
ST PHASE	<p>Selects the start phase angle for output changes made to either voltage or frequency. This allows changing the output at a specific phase angle. The ON/OFF key also uses this phase angle setting to program the output voltage up to the set level after the output relay is closed. The default value for this field is RAND. To set the start phase angle, set the cursor to the ST PHASE field and use either shuttle knob or the keypad to adjust between $\pm 360^\circ$. To set to RAND, use the BACK key.</p>

4.2.6 MEASUREMENTS Screens

The MX Series uses a DSP based data acquisition system to provide extensive information regarding the output of the source. This data acquisition system digitizes the voltage and current waveforms and calculates several parameters from this digitized data. The results of these calculations are displayed in a series of measurement data screens. A total of three measurement screens are used to display all this information.

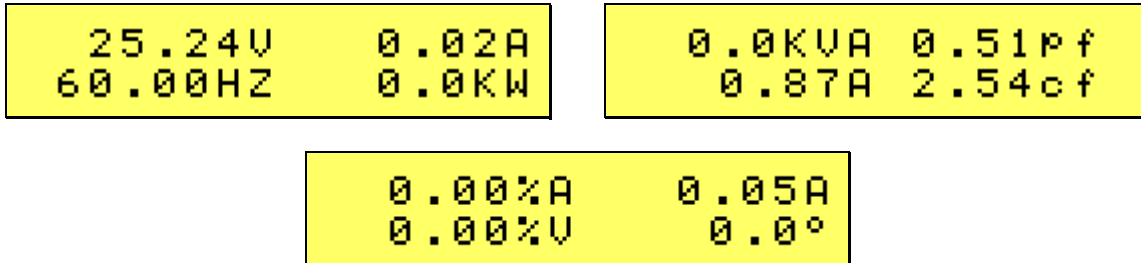

Figure 4-6: MEASUREMENT Screen

The Measurement screens available on the MX15 Series are not menus in that no changes can be made anywhere. Instead, these screens provide load parameter readouts. The measurement screens can be reached by successively pressing the **Meas** key, which will toggle to all available screens. Note that for -1 Series models, only the first two screens are available. For the -1Pi series, all three measurement screens are available.

The following parameters are available in the measurement screens:

ENTRY	DESCRIPTION
MEASUREMENTS 1	
VOLTAGE	This value is the true rms output voltage measured at the voltage sense lines.
CURRENT	This value is the true rms output current drawn by the load.
FREQ	The output frequency is measured at the sense lines.
TRUE POWER	This value is the real power.
MEASUREMENTS 2	
VA POWER	This value is the apparent power.
POWER FACTOR	This readout shows the power factor of the load.
PEAK CURRENT	This value is the instantaneous peak current. See also PEAK CURR in MEASUREMENTS 3 screen.
CREST FACTOR	This readout displays the ratio between peak current and rms current.
MEASUREMENTS 3 (iX Models only)	
CURR THD	This readout displays the total current distortion for the selected phase. The distortion calculation is based on the H2 through H50.

ENTRY	DESCRIPTION
	<p>phase. The distortion calculation is based on the H2 through H50 with the RMS current in the denominator. Note that some definitions of THD use the fundamental component (H1) of the current as the denominator.</p> <p>If desired, the user can program the power source controller to use the fundamental component as the denominator. This mode can only be programmed over the bus by sending the “MEAS:THD:MODE FUND” command. At power up or after a reset command, the mode will revert back to RMS.</p>
PEAK CURR	<p>This readout reflects the highest peak current value detected at the output. This is a track and hold peak current measurement. To measure inrush current for a unit under test, open the output relay and reset the peak current value using the BACK key. Then program the output voltage and frequency and turn on the output relay. The peak current measurement will continuously track the maximum current value detected until reset. See also PEAK CURRENT in MEASUREMENTS 2 screen.</p>
VOLT THD	<p>This readout displays the total voltage distortion for the selected phase. The distortion calculation is based on the H2 through H50 with the RMS voltage in the denominator. Note that some definitions of THD use the fundamental component (H1) of the voltage as the denominator.</p> <p>If desired, the user can program the power source controller to use the fundamental component as the denominator. This mode can only be programmed over the bus by sending the “MEAS:THD:MODE FUND” command. At power up or after a reset command, the mode will revert back to RMS.</p>
PHASE	<p>Relative voltage phase angle measurement with respect to phase A. This readout is only relevant if an external clock source is used.</p>

Update Program Functions from Measurement Screen

The Shuttle knob can be used to update voltage and/or frequency settings while the measurement readout screen is displayed. To do so, select the desired parameter to be changed while in the SET screen using the left arrow cursor. Then, select the measurement screen by pressing the MEAS button. While the measurement screen is visible, the shuttle continues to operate.

4.2.7 TRANSIENT Menu

TRAN ST COUNT	IDLE 1	TRIG SOURCE IMM TRAN STEP AUTO
VOLT # 0 VSLEW# 0	15.0 MAX	FREQ # 0 FSLEW# 0
DWELL# 0 TTLT # 0	1.000 OFF	FUNC # 0 PHASE# 0
CURR # 0	125.0	

The transient menu is used to program and execute user-defined output sequences. These output sequences are defined as a sequential list of voltage and/or current settings that can be executed in a time controlled manner.

Each step in these lists is assigned a sequence number ranging from #0 through #99. The numbering determines the order in which each step is executed.

Each step can control the voltage setting, voltage slew rate, frequency setting, frequency slew rate and dwell time. The dwell time determines how long the output dwells at the current step before progressing to the next step. Dwell times can range from 1 ms up to 900000 seconds.

Transient lists can be set up from the front panel or over the bus. The transient list can be saved with the rest of the front panel settings in one of the setup registers. (See Register Menu).

ENTRY	DESCRIPTION	
TRAN ST	Indicates the status of the transient system. Available modes of operation are:	
	IDLE	Transient system is in IDLE or inactive state. To start a transient list, press the ENTER key while on the TRAN STATE field. Note that the output must be ON to run a transient program or an error message will be displayed.
	WTRIG	Transient system is armed and waiting for a trigger event.
	BUSY	Transient system is active. A transient list execution is in progress.
COUNT	Sets the execution count for the transient system. A count of 1 indicates the transient will run 1 time. The count value can be set with the shuttle or the keypad. The count range is from 1 through 2E+08. Values below 200,000 are displayed in fixed point notation. Value higher than 200,000 are displayed as a	

ENTRY	DESCRIPTION	
	floating point number (2E+05). The display has insufficient characters to display the entire mantissa so entering values above 2E+05 from the keyboard is not recommended.	
TRIG SOURCE	Indicates the trigger source for transient system. Available trigger sources are:	
	IMM	Immediate mode. The transient is started from the front panel using the ENTER key.
	BUS	Bus mode. The transient system is started by a bus command or a group execute trigger (GET).
	EXT	External mode. The transient system is started by a user-provided external TTL trigger signal on TRIGGER IN.
TRAN STEP	Indicates the transient system execution mode. Available modes are:	
	AUTO	When triggered, the transient system will automatically execute each list point sequentially without waiting for a trigger between list points. This execution is paced by the dwell time set for each data point.
	ONCE	When triggered, the transient system will execute the first list point and wait for a new trigger once the dwell time expires. This allows triggered execution of each step in the transient list.
List parameters:		
VOLT	Step #	Voltage set point
VSLEW	Step #	Voltage slew rate in V/s
FREQ	Step #	Frequency set point
FSLEW	Step #	Frequency slew rate in Hz/s
DWELL	Step #	Dwell time in seconds. Range is 0.001 to 900000
TTLT	Step #	ON: Generates an output trigger pulse at this list step. OFF: No output trigger. The output trigger is available on the TRIG OUT on the rear panel.

ENTRY	DESCRIPTION	
FUNC	Step #	Waveform selection. Available choices are Sinusoid, Square, Clipped or any of the user provided waveforms in waveform memory (-1Pi models only).
PHASE	Step #	Phase angle set point. (Not relevant for phase A if clock mode is internal.)
CURR	Step #	Current set point

Transient List point data entry method.

Transient list points are numbered sequentially from 0 through 99 and executed in this order. Each list point or list entry has 9 parameters as shown in the table above. To enter list point data, the keypad must be used. The shuttle knob is used to increment or decrement the list point sequence number (#). The sequence number can only be increased to the next available empty (new) list point.

To move to the next or previous parameter, use the UP (▲) or DOWN (▼) cursor keys

It is not necessary to use all list points, only as many needed to accomplish the desired output sequence.

Setting Data Values

Data values can be set for each point in a list. If all data values in a specific list are going to be the same value (e.g. the current limit parameter is set to the same value for the entire transient program), only the first data value for that parameter has to be set. Setting only the first data point will automatically repeat that value for all subsequent points in the transient list.

Setting Slew Rates

Very often, output changes must be done as fast as the power source can make them. This means the transient list slew rate is set to its maximum value. If this is the case for all the data points in the list, it is sufficient to set just the first data point's slew rate for either voltage and/or current. Setting only the first point of any parameter in the list will automatically cause all points for that parameter to be set to the same value. This saves a lot of data entry time. The max slew rate can be set by entering a value of 0. When the enter key is pressed, the value will change to "MAX".

If however, one or more data points require a specific slew rate such as needed to do a ramp, all other points have to be specifically set to their required slew rates, including the maximum slew rate.

Saving Transient Lists

Once completed, a transient sequence can be saved along with the steady state setup of the instrument by using the REGISTER, SAVE menu. Registers that may be used for this purpose are 1 through 15. It is advisable to do so, especially for longer transient lists.

4.2.8 REGISTERS Menu

```
SAVE   REG #1
RECALL REG #0
```

The registers menu provides access to the non-voltage setup storage of the power source. A total of 16 front panel setups can be stored in registers numbered from 0 through 15. Each register except register 0 can hold the complete front panel setup, including the programmed transient list. This allows for quick recall of different setups and transient programs.

Register 0 is reserved to be used as the power-on setting as assigned by the user. To have the power source start in a specific setting, save the desired setting to Register 0 and assign register zero as the power-on default in the CONFIGURATION menu. Alternatively, the power source can be set to power up with the RST factory default settings. See section 4.2.9 for factory default settings.

ENTRY	DESCRIPTION	
SAVE	REG 0 – 15	<p>Saves the selected setup and transient list from memory. (Setup only for Reg 0) The shuttle knob may be used to scroll through the available list of setup register numbers. Use the ENTER key to perform the save operation.</p> <p>Register 0 can be assigned as the power-on state setup from the CONFIGURATION menu. A valid setup must be saved in REG0 to do so.</p> <p>Note that REG0 only saves the setup, not the transient list. All other registers also save the transient list.</p>
RECALL	REG 0 – 15	<p>Recalls the selected setup and transient list to memory. (Setup only for Reg 0) The shuttle knob may be used to scroll through the available list of setup register numbers. Use the ENTER key to perform the recall operation.</p> <p>Register 0 can be assigned as the power-on state setup from the CONFIGURATION menu. A valid setup must be saved in REG0 to do so.</p> <p>Note that REG0 only saves the setup, not the transient list. All other registers also save the transient list.</p>

4.2.9 CONFIGURATION Menu

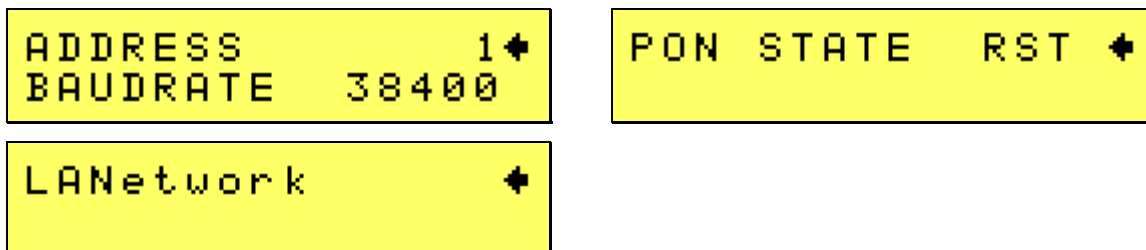

The configuration menu may be used to configure various aspects of the instrument such as the serial port (including USB and LAN), IEEE-488/GPIB address and the power-on settings of the supply.

ENTRY	DESCRIPTION											
ADDRESS	0 - 31	Sets the selected IEEE / GPIB bus address for the optional IEEE/GPIB interface. Factory default is address 1. The shuttle knob or the keypad can be used to set a value from 0 through 31. Do not use address 0 as this address is typically reserved for the GPIB controller.										
BAUD RATE	9600 19200 38400 57600 115200 230400 460800	Sets the baud rate for the RS232 communications port. Factory default is 38400 baud. Available settings are 9600 through 115200 baud. The same setting is used for USB and LAN modes. For use with either USB or LAN, the baud rate in this screen must be set to 460800 . Note: The shuttle knob can be used to scroll through these selections.										
PON STATE	REG0 RST	Determined power on state. This setting selects either non-volatile REG0 to be recalled automatically at power-on or factory default (RST). Factory default is RST, which recalls the factory settings. See below. Factory default settings are: <table data-bbox="867 1528 1354 1688"> <tr> <td>Output relay</td> <td>Open</td> </tr> <tr> <td>Voltage Range</td> <td>Low</td> </tr> <tr> <td>Mode</td> <td>AC</td> </tr> <tr> <td>Voltage</td> <td>0 Vrms</td> </tr> <tr> <td>Frequency</td> <td>60 Hz</td> </tr> </table> Note that to use REG0 for power-on default, the contents of the register must be programmed first. See section 4.2.8. If an empty register is selected, the power source will revert back to RST (factory setting).	Output relay	Open	Voltage Range	Low	Mode	AC	Voltage	0 Vrms	Frequency	60 Hz
Output relay	Open											
Voltage Range	Low											
Mode	AC											
Voltage	0 Vrms											
Frequency	60 Hz											

ENTRY	DESCRIPTION	
LANetwork	LAN	If the –LAN option is installed; pressing Enter while the cursor is on the LANetwork entry provides access to the LAN interface setting screens listed below.
<pre>IP Address NC 255.255.255.255</pre>	IP Address	<p>Displays the IP address setting. This value can be changed by pressing the SET key and entering a new value from the keypad. Use the numeric data pad to enter each field. To move between the four fields, use the decimal point key on the keypad.</p> <p>To set a fixed IP address, press SET and enter the desired IP address. To set the unit to DHCP mode, press SET and enter all zeros (0.0.0.0) as the IP address and cycle power two times. The obtained IP address will be displayed after the second power on.</p> <p>Any change to this value will NOT take effect until after power on the unit has been cycled. When changing mode from static IP to DHCP, it is necessary to cycle power on the unit twice, once to change mode and again to obtain and display a new IP address from the network.</p>
<pre>MAC Address 0:20:4A:9A:02:FD</pre>	MAC Address	<p>Displays the network Media Access Control address. This value is fixed and cannot be changed. The same MAC is normally printed on the model serial tag. The MAC address is shown as six hexadecimal numbers separated by a colon, e.g. 02:20:4A:9A:02:FD. Note that the leading '0' is never visible due to the maximum number of LCD characters per line.</p>
<pre>GWAddress NC 255.255.255.255</pre>	GWAddress	<p>Gateway address setting. A default gateway is a node (a router) on a computer network that serves as an access point to another network.</p> <p>This value can be changed by pressing the SET key and entering a new value from the keypad. Use the numeric data pad to enter each field. To move between the four fields, use the decimal point key on the keypad.</p> <p>Any change to this value will NOT take effect until after power on the unit has been cycled.</p>
<pre>HostBits 8 NC Port No 5025</pre>	HostBits	<p>Number of host bits as opposed to network bits in network mask. A CIDR class C network uses 24 network bits and 8 host bits. (Class A = 24, Class B = 16).</p> <p>This value can be changed by pressing the SET key and entering a new value from the keypad. Any change to this value will NOT</p>

ENTRY	DESCRIPTION	
		take effect until after power on the unit has been cycled.
<pre>HostBits 8 NC Port No 5025</pre>	Port No	<p>TCP remote port number. This value must be set to 5025 (SCPI) to support the built in web page.</p> <p>This value can be changed by pressing the SET key and entering a new value from the keypad. Any change to this value will NOT take effect until after power on the unit has been cycled.</p>

4.2.10 CALIBRATION Menus

Measurement Calibration:

```
VIEW ANGLE    0
CAL PWORD    0
```

```
MVOLT FS    0
MCURR FS    0
```

Output Calibration:

```
VIEW ANGLE    -2
CAL PWORD    0
```

```
VOLT FS    17251
VOLT ZERO  -91
```

```
IMP REAL FS    0
IMP REAC FS    0
```

```
IMP REALin
IMP REACin
```

```
PHASE OFST  0.0
```

The measurement calibration menu can be used to perform routine calibration of the internal measurement system. The recommended calibration interval is 12 months. To enter the calibration screens, the calibration password must be entered first.

The output calibration menu can be used to perform routine calibration of the voltage output and programmable impedance. The recommended calibration interval is 12 months. To enter the calibration screens, the calibration password must be entered first.

Note: Refer to chapter 6 for details on routine calibration procedures and equipment requirements. Do not attempt calibration without consulting the user manual.

This menu also contains the LCD viewing angle adjustment.

ENTRY	DESCRIPTION	
VIEW ANGLE	-10 to +10	LCD viewing angle adjustment.
CAL PWORD		Calibration password required to access all calibration screens. The calibration password is 5000. The password can be entered using the keypad or shuttle followed by the ENTER key.
		Measurement Calibration Screens
MVOLT FS		Calibration coefficient for full-scale voltage measurement.
MCURR FS		Calibration coefficient for full-scale current measurement.

ENTRY	DESCRIPTION	
		Output Calibration Screens
VOLT FS		Calibration coefficient for voltage output.
VOLT ZERO		Zero offset voltage calibration factor.
IMP REAL FS		Full scale resistive output impedance calibration factor.
IMP REAC FS		Full scale inductive output impedance calibration factor.
IMP REAL0in		Minimum resistive AC source output impedance. The source has an output impedance greater than zero. This value determines the minimum resistive component of the AC source output impedance.
IMP REAC0in		Minimum reactive AC source output impedance. The source has an output impedance greater than zero. This value determines the minimum resistive component of the AC source output impedance.
PHASE OFST	0.0 - 360.0	Phase offset calibration factor. Compensates for phase shift caused by AC amplifier.

4.2.11 APPLICATIONS Menu

Note that some of the application options listed in this section may not be available on all MX15 models and may not be configured. In this case, these fields in these menus will display “N/A” (not applicable) and no access to these menus will be available.

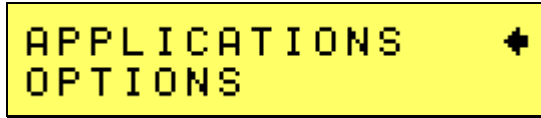

The Applications menu provides access to application specific firmware functions if available. Note that there may be no applications installed in which case this screen will still be shown but has no function.



Possible applications are DO160 and MIL704. To access either of the application screens, position the cursor on the APPLICATIONS entry and press the ENTER key. Select the desired application and press ENTER.



4.2.12 OPTIONS Menu

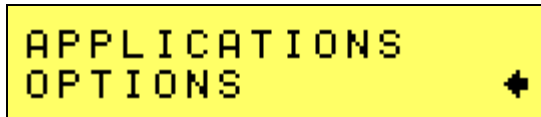

The Options menu provides access to available optional features. Note that there may be no options installed in which case this screen will still be shown but has no function. The option settings are protected and cannot be changed by the user. These screens are provided for information purposes only.

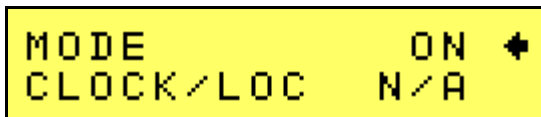
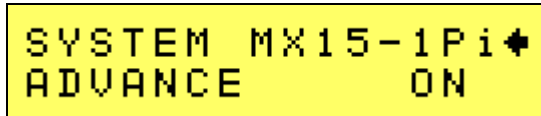

ENTRY	DESCRIPTION	
SYSTEM		Shows model number.
ADVANCE	ON	Designates the advanced measurement and arbitrary waveform capability (1Di)

ENTRY	DESCRIPTION	
		arbitrary waveform capability (-1Pi).
	N/A	This feature is not available on –1 models. N/A is shown.
CLOCK/LOC	N/A	Clock and lock is an option. If no –LKM option is installed, this field will show N/A.
	MAST	-LKM Option installed. The unit can be used as a Clock and Lock system master or stand-alone.
	AUX	-LKS option installed. The unit can be used as a Clock and Lock system auxiliary or stand-alone.
MIL704		Avionics test - MIL-STD 704 revs D and E Option (as interpreted by California Instruments at time of release)
DO160		Avionics test – RTCA DO160 Option
MS704		Avionics test - MIL-STD 704 revs A through F Option (according to Appendix A released with rev F)
ABD		Avionics test – Airbus ABD0100.1.8 Option
LF		Low Frequency Option – Frequency will be limited to 500Hz
MB		Multi-Box Option – Each MX15 in a multibox configuration will have its own controller.

4.2.13 Elapsed Time and Temperature Screen

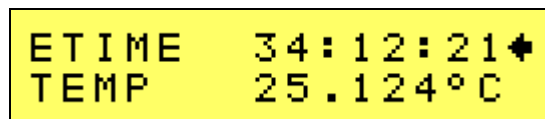

The Etime/Temp screen displays the elapsed time since the power source has first been turned on. This is an accumulated total time in hours, minutes and seconds.

The same screen also displays the internal temperature of the power supply.

ENTRY	DESCRIPTION	
ETIME	01:23:45	The ETIME field displays the total accumulated elapsed time for the instrument since it's initial manufacture. This value

ENTRY	DESCRIPTION	
		cannot be changed or reset.
TEMP	37.342°	The TEMP field is not a user selectable parameter but rather a read-out of the internal temperature in degrees Celsius. It is provided for informational purposes only.

4.2.14 LIMIT Menu

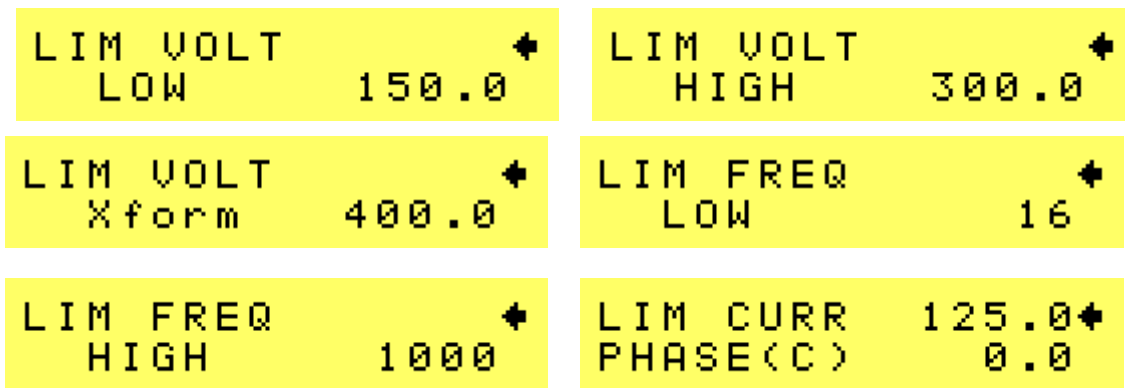

The Limit menu displays the maximum available value for voltage, frequency and current range of the power supply. This screen is used for information only and contains no user changeable fields. The limit values shown cannot be changed.

ENTRY	DESCRIPTION	
LIM VOLT LOW	Low Voltage Range	Displays maximum available output voltage in the low voltage range.
LIM VOLT HIGH	High Voltage Range	Displays maximum available output voltage in the high voltage range.
LIM VOLT Xform	Extra Voltage Range	Displays maximum available output voltage in the extra voltage range. (HV or EV option)
LIM FREQ LOW	Low Frequency Limit	Displays minimum available output frequency.
LIM FREQ HIGH	High Frequency Limit	Displays maximum available output frequency
LIM CURR	C range	Displays maximum available current in low voltage range at full power.
PHASE (C)	Phase Setting	Displays phase angle for phase C. Valid values are 120 for three-phase or mode configuration, 0 for single-phase only configuration. Any other value indicates split (2) phase configuration. The MX15 is single phase only, so this will always show a value of 0.

4.3 Output Programming

4.3.1 Set the Output

Output parameters are all set from the PROGRAM screen.

1. Use the MENU key and select the PROGRAM entry.
2. Press the ENTER key to bring up the PROGRAM menu.

or

2. Use the SET key to directly bring up the PROGRAM menu.

There are two methods for programming output parameters:

IMMEDIATE mode

SET mode

4.3.2 Slewing Output Values in IMMEDIATE Mode

The default mode of operation is an immediate mode in which changes to output parameters made with the knob or the entry keypad are immediately reflected at the output.

To change the output voltage:

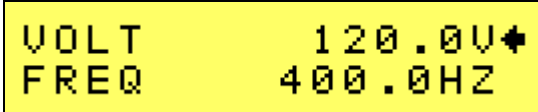

```
VOLT      120.0V↔
FREQ      400.0HZ
```

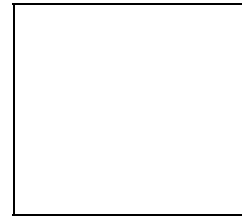

1. Place the cursor on the VOLT entry
2. Rotate the shuttle knob clockwise to increase the value, counterclockwise to decrease the value or use the Keypad to enter a value and press the Enter key.

These changes take effect immediately.

To change the output frequency:

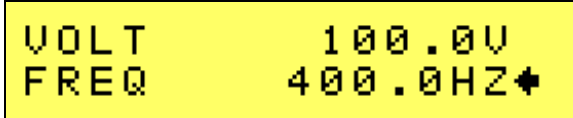

```
VOLT      100.0V
FREQ      400.0HZ↔
```

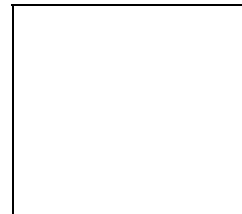

1. Place the cursor on the FREQ entry
2. Rotate the shuttle knob clockwise to increase the value, counterclockwise to decrease the value or use the keypad to enter a value and press the Enter key.

These changes take effect immediately.

4.3.3 Change Output Values in SET Mode

The SET mode of operation is a mode in which changes to output parameters made with the knob or the entry keypad do not affect the output until the **Enter** key is pressed. The AC source is put in this SET mode by pressing the **Set** key twice. A blinking cursor indicates SET mode is active.

To change the output voltage:

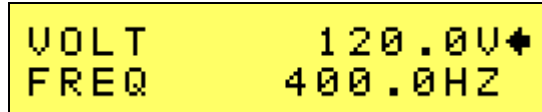

```
VOLT      120.0V↔
FREQ      400.0HZ
```

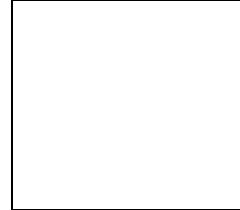

1. Press the **Set** key twice
2. Place the cursor on the VOLT entry
3. Rotate the shuttle knob clockwise to increase the value, counterclockwise to decrease the value or enter a new value using the keypad but do not press the **Enter** key yet.
4. A blinking underline cursor will appear in the data for the VOLT field to indicate a change in settings but the output remains unchanged.
5. Place the cursor on the FREQ entry using the down arrow key.
6. Rotate the shuttle knob clockwise to increase the value, counterclockwise to decrease the value or enter a new value using the keypad but do not press the **Enter** key yet.
7. A blinking underline cursor will appear in the data for the FREQ field to indicate a change in settings but the output remains unchanged.
8. Press the **Enter** key.

Both new voltage and frequency output values are now present at the output. The unit has returned to immediate mode of operation until the **SET** key is pressed again.

Note that output settings such as voltage and frequency can be changed from the measurement screen as well. If all three phases are selected on three phase models, slewing the shuttle knob will change the output voltage on all three phases. If only one phase is selected, only the output of the selected phase will be affected.

4.4 Waveform Management [1Pi Controller only]

The MX Series with 1Pi controller employs independent arbitrary waveform generators for each phase. This allows the user to create custom waveforms. In addition, three standard waveforms are always available. This chapter covers issues that relate to defining, downloading and managing custom waveforms.

4.4.1 Standard Waveforms

For most AC applications, a sine wave shape is used. The sine wave is one of the standard waveforms provided on all MX Series models. This standard sine wave is always available and is the default waveform at power-on. On MX models with the 1Pi controller, two more standard waveforms are available, square and clipped.

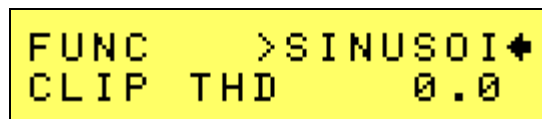

```

FUNC >SINUSOI➤
CLIP THD 0.0
  
```

Figure 4-7: Selecting a Waveform

The square wave provides a high frequency content waveform with relative fast rise and fall times. Due to AC amplifier bandwidth limitations, the frequency content of the standard square wave has been kept within the amplifier's capabilities. As the fundamental frequency is increased, the relative contribution of higher harmonics is reduced.

The clipped sine wave may be used to simulate voltage distortion levels to the unit under test. The total harmonic distortion level may be programmed in percent using the CLIP THD field of the PROGRAM menu. Changing the distortion level of the CLIP waveform forces the AC source to regenerate the CLIPPED sine wave's data points and reload the waveform register with the newly requested data. This process requires the output to be dropped. To avoid interrupting the voltage output to the unit under test, select a different waveform such as the standard sine wave first, change the clip level and change the waveform back to the CLIPPED sine wave. This will avoid any output interruption.

4.4.2 Creating Custom Waveforms

The 1Pi controller provides four groups of 50 custom defined waveforms each for a total of 200 waveforms in addition to the 3 standard waveforms. Of these four groups, one may be active at a time.

Custom waveforms cannot be created from the front panel of the MX Series. Rather, they have to be downloaded through the IEEE-488 or RS232C interface. A Windows based program is included with the MX Series that allows waveforms to be created and downloaded easily. This Graphical User Interface program allows waveforms to be created by specifying harmonic amplitudes and phase angles with respect to the fundamental. It also offers an arbitrary waveform data entry mode that allows individual data points to be specified.

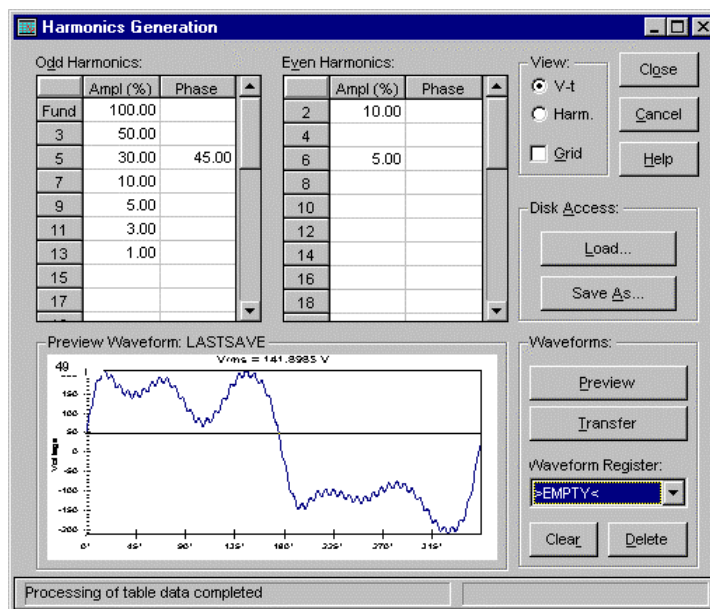

Figure 4-8: Custom Waveform Creation with GUI Program

Once downloaded, waveforms remain in non-volatile memory and will be visible in the PROGRAM menu for selection. The user can assign a 12-character name to each custom waveform. Avoid using any of the standard waveform names (SINE, SQUARE or CLIPPED) as these names will not be accepted.

Waveforms may be deleted using the IEEE-488 or RS232C interface as well. Custom waveforms cannot be deleted from the front panel however to avoid accidental erasure.

4.4.3 Waveform Groups

Waveform groups extend the number of available custom waveform to 200. Each group can contain up to 50 user-defined waveforms. Groups are numbered 0 through 3 and may be selected only by using the included Gui. To switch waveform groups, proceed as follows:

1. Establish a connection to the unit using RS232 or GPIB interface with the provided Gui. Send the command: PONS:WGR x, where x is 0-3 depending on which group is to be selected.
2. To activate your new selection, YOU MUST CYCLE THE POWER so the AC source re-initializes. If the source is operated over the bus, a IEEE-488 Device Clear or reset command (*RST) command will have the same effect.

The new wave group will be active after you turn the power to the unit back on.

4.4.4 RMS Amplitude Restrictions

The output of a sine wave may be programmed to the full rms value of the voltage range selected. If the AC source is in the 300 V range, the maximum programmable rms voltage is 300 Volt. If a custom waveform is used however, the maximum programmable rms voltage may be less than the maximum range value. The voltage range limit is based on the use of a sine wave with a 1.414 crest factor. A 300 V rms sine wave has a 424 Volt peak voltage. The AC source has a maximum peak voltage capability that is determined by the selected voltage range. If the

user selects a custom waveform with a crest factor that is higher than 1.414, the peak voltage would exceed this maximum if the rms voltage were to be programmed at 300 V rms.

The MX Series power source automatically limits the maximum allowable programmed rms voltage of any custom waveform by calculating the crest factor of the selected waveform and controlling the rms limit accordingly. Thus, each custom waveform may have a different maximum rms value. The 1Pi controller will prevent the user from programming the rms voltage above this limit. If a value is entered in the PROGRAM menu above this value, a “Voltage peak error” message is generated.

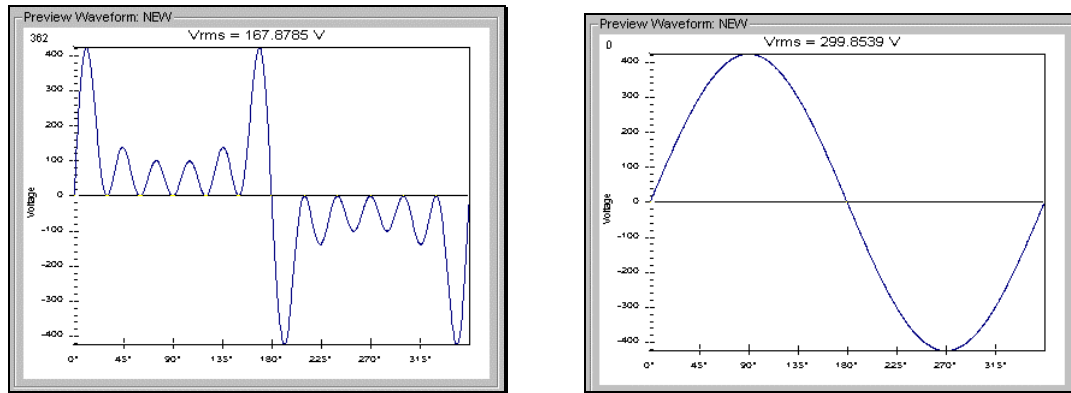

Figure 4-9: Waveform Crest Factor Affects Max. rms Voltage

The figure shown here illustrates the relationship between the crest factor of the wave shape (or its “peakiness”) and the maximum peak voltage allowed for a given voltage range. Since the peak voltage cannot exceed the AC source’s capabilities, the programmable rms voltage has to be restricted, in this case to only 167.8785 volt for the waveform on the left. The sine wave on the right can be programmed to the full 300 V rms as this still falls within the same peak voltage limitation of the AC source.

If the MX Series is used over the bus, the “:VOLT? MAX” query command can be used to determine the maximum allowable RMS voltage for the selected waveform. Using the returned value as part of a program will prevent range errors.

4.4.5 Frequency Response Restrictions

The user may create a waveform that contains any number of harmonic frequencies of the fundamental. The AC Source itself however has a finite signal bandwidth and will attenuate higher frequency components of the signal. To limit the maximum frequency component of the output signal, the 1Pi controller automatically applies a band-pass filter to all custom waveforms as they are downloaded. The controller implements the following process for user defined waveforms:

Each down loaded waveform will have a computed frequency limit that is less than or equal the maximum frequency limit of the AC source. The frequency limit is a function of the harmonics content of the waveform and will follow the equation below.

$$F_{max_n} = F_{max}/(\text{level} * h_n)$$

If F_{max} is below the minimum frequency limit, the waveform will be rejected at down load time and the label will be deleted from the waveform catalogue.

If the MX Series is used over the bus, the “:FREQ? MAX” query command can be used to determine the maximum allowable fundamental frequency for the selected waveform. Using the returned value as part of a program will prevent range errors.

Limits assume a program of full-scale voltage. No adjustments for voltage setting are made below the full-scale value.

Waveform selection and frequency programming will be subject to the above limit. An error message will be generated to reflect this type of error:

"22,Waveform harmonics limit"

Transient editing will also generate the above error during keyboard entry. Remote transient entry will not check for the error until transient execution.

4.4.6 Switching Waveforms

Waveforms can be switched as part of the transient system. Each transient type setup menu has a FUNCTION field. This field allows selection of any of the standard or custom waveforms available in the selected group. Refer to the section on transients for more details on using transient list to switch output waveforms.

4.5 Standard Measurements

Standard measurements are always available through the MEAS key on the front panel. These measurements are spread across two screens to enhance readability. Switching between these screens can be done by successively pressing the MEAS button on the front panel. This will cause the screen to cycle through all available measurement screens.

4.5.1 Standard Controller Measurements

For MX Series power sources with the –1 standard controller, the following two measurement screens are available:

Mode	AC	DC	
MEASUREMENTS 1			
VOLTAGE	AC rms voltage	DC Voltage	
CURRENT	AC rms current	DC Current	
FREQUENCY	Frequency	n/a	
POWER	Real power	power	
MEASUREMENTS 2			
VA POWER	Apparent power	power	
PEAK CURR	Highest AC current found	Highest DC current found	
POWER FACT	Power factor	n/a	
CREST FACT	Crest factor	n/a	

4.5.2 3Pi Controller Measurements

For MX Series with the -1Pi controller, the following four measurement screens are available:

Mode	AC	DC	AC+DC
MEASUREMENTS 1			
VOLTAGE	AC rms voltage	DC Voltage	AC rms voltage
CURRENT	AC rms current	DC Current	AC rms current
FREQUENCY	Frequency	n/a	Frequency
POWER	Real power	n/a	n/a
MEASUREMENTS 2			
VA POWER	Apparent power	power	Apparent power
PEAK CURR	Highest AC current found	Highest DC current found	Highest AC current found
POWER FACT	Power factor	n/a	Power factor
CREST FACT	Crest factor	n/a	Crest factor
MEASUREMENTS 3			
VOLT THD	Voltage distortion	n/a	Voltage distortion
CURR THD	Current distortion	n/a	Current distortion
INST PK CURR	Instantaneous peak current	Highest DC current found	Instantaneous peak current
PHASE	Phase angle	n/a	Phase angle

Note: The V and I distortion calculations are based on H2 through H50 with the RMS current in the denominator. Note that some definitions of THD use the fundamental component (H1) as the denominator. This may result in different readings between instruments depending on the implementation chosen.

Measurements are always running in the background. When the user selects a measurement screen for display, the AC source first updates all the measurement parameters before displaying the requested screen. This process may take up to a second. Consequently, pressing the MEAS key may not always bring up the selected screen immediately. There will be a perceptible delay. This will prevent the screen from appearing with invalid or blank readouts.

The measurement method for voltage and current will depend on the power source's operating mode. The following table shows the return value type (rms or average) and method of coupling when the measurement command is initiated with a different extension at various operating modes (AC, DC or AC + DC).

Measurement Extension and Coupling	Operating Mode		
	AC	DC	AC + DC
AC	rms	rms	rms
DC	rms	rms	average
Coupling	AC	DC	DC

4.5.3 Accuracy Considerations

Any measurement system has a finite accuracy specification. Measurement specifications are listed in Section 2. When using the AC source for measurement purposes, always consider these specifications when interpreting results. Measurement inaccuracies become more

pronounced as the signal being measured is at the low end of the measurement range. This is particularly relevant for low current measurements. The MX Series is a high power AC and DC source optimized for providing and measuring high load currents. When powering low power loads, measurement inaccuracies on rms and peak current measurements will greatly affect derived measurements such as power, power factor and crest factor.

The measurement system on the MX15 Series uses a data acquisition system with a 48 kHz bandwidth. This means that high frequency components of the measured signal are filtered out. Any contribution to the rms value of voltage and current above this cutoff frequency will not be reflected in the MX Series measurements. When using an external measurement reference, this may account for discrepancies in readings.

4.6 Advanced Measurements [1Pi Controller only]

The 1Pi controller offers advanced power analyzer measurement capabilities. They include Harmonic Analysis and Waveform Acquisition, These functions are only available using the provided Gui program since they cannot be graphically displayed on the two line display.

4.7 Transient Programming

4.7.1 Introduction

Transient programming provides a precise timing control over output voltage and frequency changes. This mode of operation can be used to test a product for susceptibility to common AC line conditions such as surges, sags, brownouts and spikes. By combining transient programming with custom waveforms [*1Pi Controller only*], virtually any AC condition can be simulated on the output of the AC source.

The default voltage mode is FIXED which means the output voltage is constant and remains at the level set by the user. Changes made to the output voltage made from the PROGRAM menu take effect immediately. In front panel operation mode, the voltage and frequency slew rates (rate of change) are always at their maximum of 1E9 V/s and 1E9 Hz/s. Slew rate programming is only possible over the IEEE-488 or RS232C bus. On power up, the AC source always reverts to the maximum slew rate for both voltage and frequency.

4.7.2 Using Transient Modes

The voltage can be programmed in the following transient operating modes:

STEP	causes the output to permanently change to its triggered value.
PULSE	causes the output to change to its triggered value for a specific time, as determined by the Pulse menu parameters.
LIST	causes the output to sequence through a number of values, as determined by points entered in the List menu.
FIXED	disables transient operation for the selected function.

Note: Only list transients can be programmed from the front panel. All others must be done using the provided Gui program.

4.7.3 Step Transients

Step transients let you specify an alternate or triggered voltage level that the AC source will apply to the output when it receives a trigger. Because the default transient voltage level is zero volts, you must first enter a triggered voltage before you can trigger the AC source to change the output amplitude. Step transients can only be programmed through the bus, not the front panel. Refer to the SCPI Programming Manual for more information about programming Step transients and triggers.

4.7.4 Pulse Transients

Pulse transients let you program the output to a specified value for a predetermined amount of time. At the end of the Pulse transient, the output voltage returns to its previous value. Parameters required to set up a Pulse transient include the pulse count, pulse period, and pulse duty cycle. An example of a Pulse transient is shown in Figure 4-10. In this case, the count is 4, the pulse period is 16.6 ms or 60 Hz and the duty cycle is 33%.

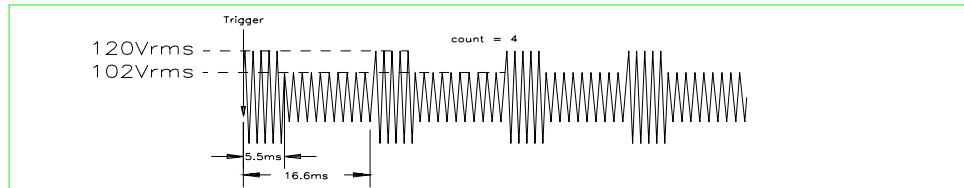

Figure 4-10: Pulse Transients

Note that Pulse transients can only be programmed over the bus, not the front panel. Refer to the SCPI Programming Manual for more information about programming Pulse transients and triggers.

4.7.5 List Transients

List transients provide the most versatile means of controlling the output in a specific manner as they allow a series of parameters to be programmed in a timed sequence. The following figure shows a voltage output generated from a list. The output shown represents three different AC voltage pulses (160 volts for 33 milliseconds, 120 volts for 83 milliseconds, and 80 volts for 150 milliseconds) separated by 67 millisecond, zero volt intervals.

Transient list programming is supported from the front panel and may be accessed by selecting the TRANSIENTS menu. Transient lists can also be programmed over the bus. Refer to the SCPI Programming Manual for more information about programming List transients and triggers over the bus.

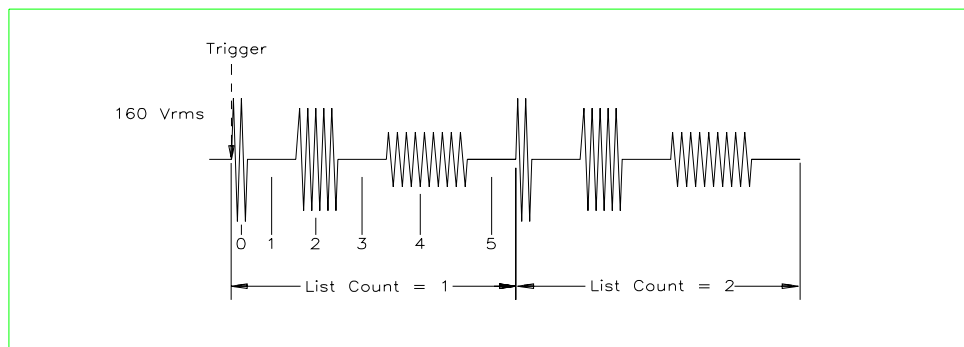

Figure 4-11: List Transients

The list specifies the pulses as three voltage points (point 0, 2, and 4), each with its corresponding dwell point. The intervals are three zero-voltage points (point 1, 3, and 5) of equal intervals. The count parameter causes the list to execute twice when started by a single trigger.

The output transient system allows sequences of programmed voltage and or frequency changes to be executed in a time controlled manner. Changes can be either step changes (maximum slew rate) or ramps (specified slew rates).

The section provides some examples of programming output changes (transients). Transients are defined as a series of numbered steps in a list. The list is executed sequentially. Each step has a number of fields that can be set by the user:

Voltage, Voltage slew rate, Frequency, Frequency slew rate, Current, Function, Dwell time, Trigger out.

The voltage, current and frequency settings are the same as one would do from the setup screen using the shuttle knob or keypad. At each step, the output will be set to the specified voltage, current and/or frequency. The rate of change for voltage and frequency is determined by the slew rate set. Current slew is fixed at MAX and cannot be programmed.

If the voltage is changed from 10 Vac to 20 Vac and the V slew is set to 100 V/sec, the voltage will ramp from 10 to 20 Vac in 100 ms. ($[20 - 10] / 100 = 0.1$ sec). The dwell time is the time the output will remain at this setting. In this example, it should be set long enough to reach the final programmed value of 20 Vac, e.g. it should be at least 0.1 sec. If not, the voltage will never reach the final value of 20 Vac before the next step in the transient list is executed. The dwell time may be set longer than 0.1 sec in this example. If for example the dwell time is set to 1.0 sec, the voltage will ramp from 10 Vac to 20 Vac over a 0.1 sec period and then remain at 20 Vac for 0.9 sec.

Once the dwell time set for a step in the list expires, the next step is entered (if available, if not, execution stops and the output remains at the final values set in the last step of the list.)

Note that while there are parameters for both voltage and frequency level and slew rates, there is only one dwell time, which applies to each step in the transient list.

Front panel entry only supports the LIST mode of operation. For Pulse and Triggered modes, the remote control interface must be used.

When entering transient lists, each list must be entered sequentially starting with step #0. If a list point is not yet set, the step number cannot be increased past it.

The following sample illustrates the use of transient system to program controlled output changes.

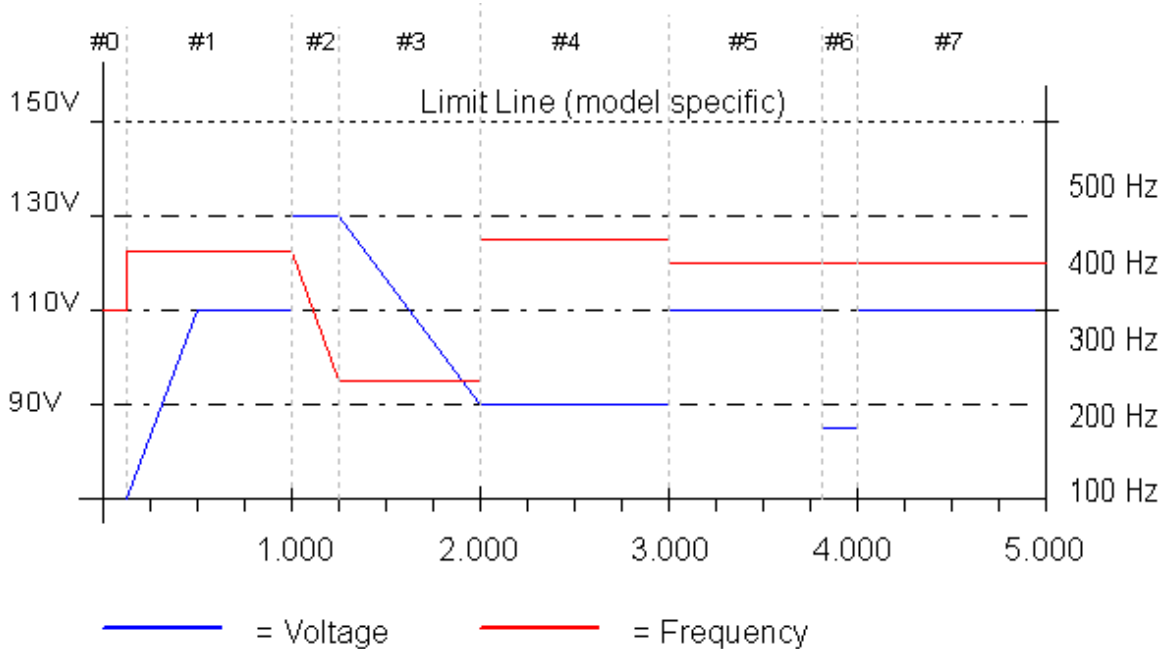

Figure 4-12: Sample Transient Output Sequence

This output can be accomplished using the following transient list.

Step # (data point)	Volt	VSlew	Frequency	FSlew	Dwell
0	70.00	MAX	360.0	MAX	0.100
1	110.00	100.0	440.0	MAX	0.900
2	130.00	MAX	240.0	800.00	0.250
3	90.00	53.3	240.0	MAX	0.750
4	90.00	MAX	460.0	MAX	1.000
5	110.00	MAX	400.0	MAX	0.800
6	88.00	MAX	400.0	MAX	0.200
7	110.00	MAX	400.0	MAX	1.000

Table 4-2: Sample Transient List

4.7.6 Switching Waveforms

The FUNCTION field available in each transient list event setup menu may be used to dynamically switch waveforms during transient execution. This allows different waveforms to be used during transient execution. Waveforms may be switched without the output of the source being turned off. For three phase configurations, each phase has its own waveform list so different waveforms may be programmed on different phases during transient execution.

Figure 4-13 illustrates the concept of using different waveforms at different steps in a transient list. In this case, the change was programmed to occur at the zero crossing. Any phase angle can be used to start the transient execution however. To keep the phase angle synchronization, the dwell times have to be set to an integer number of periods. Over long periods of time, phase synchronization may get lost due to timing skew between the waveform generator and the transient state machine.

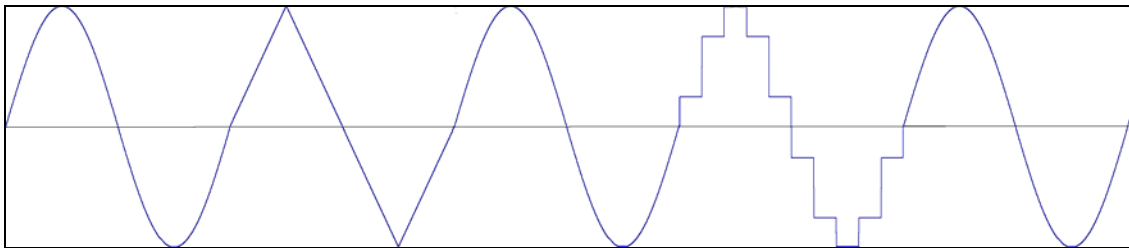

Figure 4-13: Switching Waveforms in a Transient List

4.7.7 Transient Execution

```

TRAN ST      IDLE
COUNT      1
  
```

Figure 4-14: TRANSIENT Menu

A transient list can be executed from the TRANSIENT menu. To start a transient list, position the cursor on the TRAN ST field as shown in Figure 4-14 and press the ENTER key. Transients may be aborted by pressing the ENTER key again while on the same field as the field changes to ABORT while a transient execution is in progress. For short duration transients, this will likely not be visible, as the transient will complete before the screen is updated. Longer duration transients however may be aborted in this fashion.

4.7.8 Saving Transient List Programs

When the AC source is turned off, the transient list that was programmed is not automatically retained. Thus, if you turn the unit off, you will lose your programmed transient list. However, transient programs may be saved in nonvolatile memory for later recall. This allows multiple transient list programs to be recalled quickly without the need to enter all parameters each time. Transient lists are stored as part of the overall instrument front panel setup in any of the available setup registers.

To save the transient list you created in the previous example, proceed as follows:

```

SAVE      REG #1
RECALL   REG #0
  
```

1. Press the **Menu** key repeatedly until the REGISTERS / CONFIGURATION menu is displayed.
2. Move the cursor to the REGISTERS entry and press the ENTER key.
3. The cursor will default to the SAVE REGISTER # position. Enter a number from 1 through 15 and press the ENTER key. **DO NOT USE REGISTER 0 (REG0)** as it is reserved for power-on setting recall and does not include a transient list.
4. A message will appear indicating that the front panel settings and the transient list data have been saved in the setup register you selected.

5 Principle of Operation

5.1 General

An explanation of the circuits in the MX15 Series is given in this section. Refer to Figure 5-1 for a basic functional block diagram of the system. Figure 5-2 shows a more detailed system interconnect for a MX15-1 single-phase output unit.

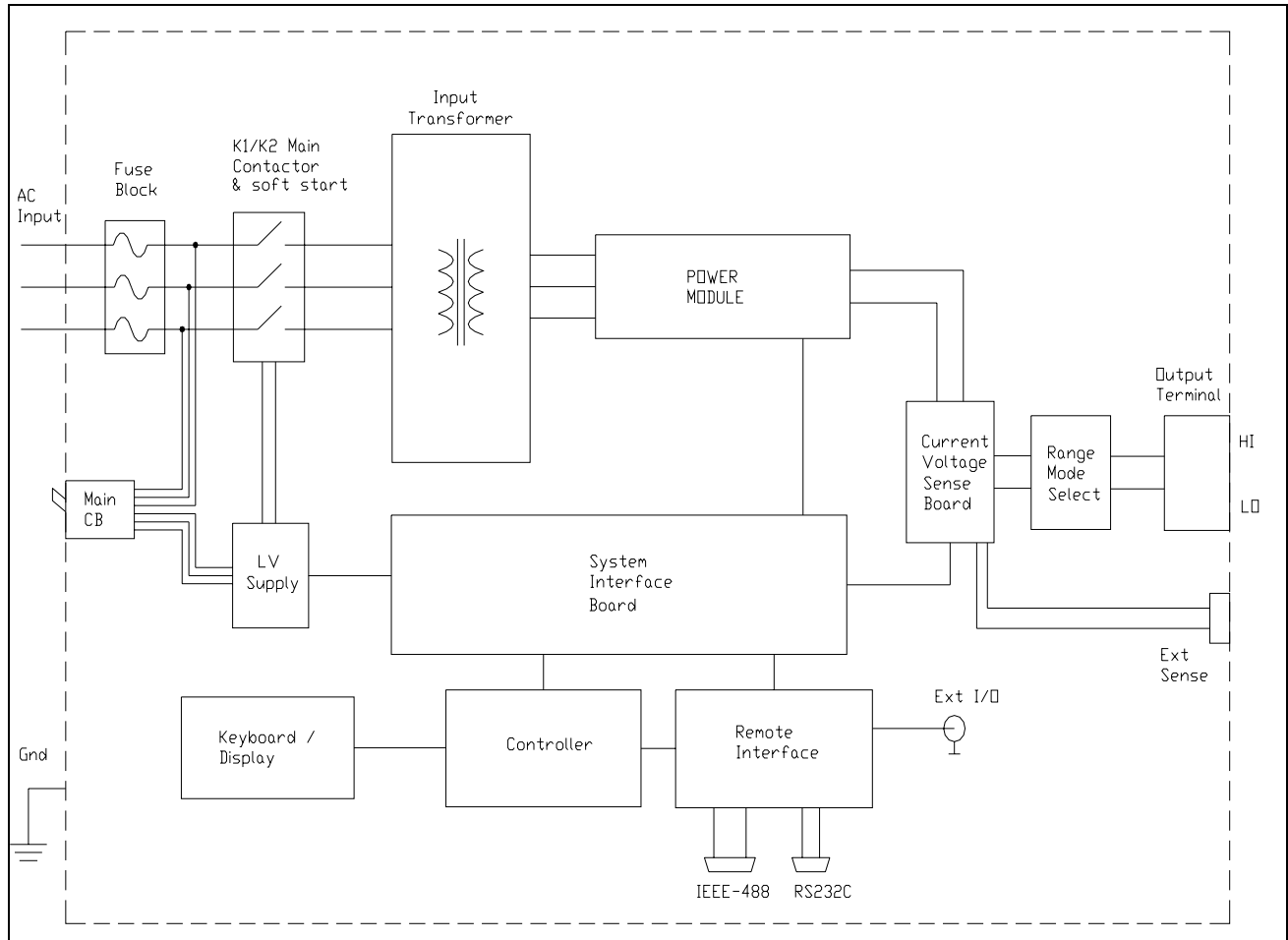

Figure 5-1: MX Series Functional Block Diagram

5.2 Overall Description

Three-phase input power is routed to the back of the cabinet to a fuse holder terminal block. The rear access panel has to be removed to gain access to the AC input connection fuse block. From the fuse block, the AC input is connected to the three-phase input transformer primary. The input transformer provides the required isolation between input and output of the MX and accommodates various input voltage ranges by employing multiple taps. Three sets of single-phase output secondaries are provided by the transformer to produce three 140 VAC unregulated output AC buses. Each of these outputs is fed into the power module. The power module is located in the middle of the MX chassis and can be pulled out from the front after removing the front access panel and disconnecting the power input and output wiring.

The power module contains a three-phase PFC power input module. The PFC module acts as a boost converter using a PWM converter topology to generate a 450 VDC regulated bus. A bank of high capacity electrolytic capacitors for each DC bus ensures ride through capability during brown-outs and high current demands.

The DC bus provides power to the AC amplifier. Each amplifier in turn consists of four amplifier modules labeled #1 (A1, A2) and #2 (A1, A2). These four amplifier modules are identical and interchangeable but all four must always be present.

The output of the amplifier can be either AC, DC or a combination of AC and DC. The mode is controlled by the CPU controller based on user selection. All four amplifier modules within each power module are controlled by a single Modulator board. The modulator board contains a high frequency PWM modulator and additional control circuitry.

The CPU controller / oscillator assembly generates the reference waveforms and provides frequency, amplitude, and impedance control. A current and voltage sense board is located at the left bottom of the unit (looking from the rear) and is used to sense all output current and voltage for both control and measurement purposes. The current sensor board, in conjunction with the CPU controller, also supports the programmable RMS current limit function.

The system interface board controls all interaction between controller, power modules and current sensor board. The system interface board is located in the top compartment of the MX15 along with the controller.

Low voltage Power to the controller, amplifiers, system interface board and sensor board is provided by a separate Low Voltage DC supply (LV Supply). This LV Supply takes three-phase AC input directly from the AC input line through circuit breaker CB1 located on the front on the MX15. This circuit breaker functions as the main power on/off switch of the MX15 unit.

The LV Power Supply board converts the AC input into a number of isolated low voltage regulated DC supplies that are distributed throughout the MX15 chassis. The LV power supply also supplies coil power for all contactors, including the AC mains contactor (K2). A small fan is located near the LV Supply to provide sufficient cooling of the supply and the other modules in the top section of the MX.

The individual assemblies are described in more detail in the following paragraphs. Refer to Figure 5-1 for an overall functional block diagram.

5.3 Controller Assembly

The Controller Assembly is located in the top section of the MX15 unit. To access this assembly, the top cover needs to be removed. The controller contains the main oscillator, which generates the sine wave signal setting the frequency, amplitude and current limit level. It also senses the output voltage to provide closed loop control of the output. The controller also handles all user interface and remote control related tasks.

5.3.1 CPU Controller

This board assembly, A2, consists of the components for the CPU (DSP), generating the Phase waveform signal to the power amplifier, programmable impedance (MX15-1Pi model only) and all of the program, waveform and data memory. In addition, the waveform board contains the circuits for all measurements. The clock and lock circuit required to support the clock and lock mode of operation of multiple MX units is also on this board assembly.

5.3.2 Keyboard / Display Board

The keyboard/display assembly is assembly A5. It is mounted to the front panel and holds the 21 rubber keys. It also has the LCD display. A shaft encoder is mounted on the board that is used as a shuttle input to allow slewing of setup parameters. If the MX15 system is used over one of the remote control interfaces, the keyboard functions can be locked out by asserting the REMOTE state. See the MX Series Programming Manual (P/N 9003-961) for details.

5.3.3 GPIB / RS232 or GPIB / RS232 / USB / LAN IO Board d

This board assembly is identified as A1. It has the IEEE 488, RS232 and USB transceivers and optionally an Ethernet interface (-LAN option). USB and LAN are available on top assembly 7005-403 MX models only. It also has isolators to provide safety isolation for both interfaces and additional user accessible I/O lines. Additional user accessible inputs and outputs available through this assembly are:

- Trigger Input BNC
- Trigger Output BNC
- Function Strobe BNC
- Remote Inhibit (terminal strip)
- External Sync (terminal strip)
- Clock BNC (option)
- Lock BNC (option)
- Output Status (Available on top assembly 7005-403 only.)

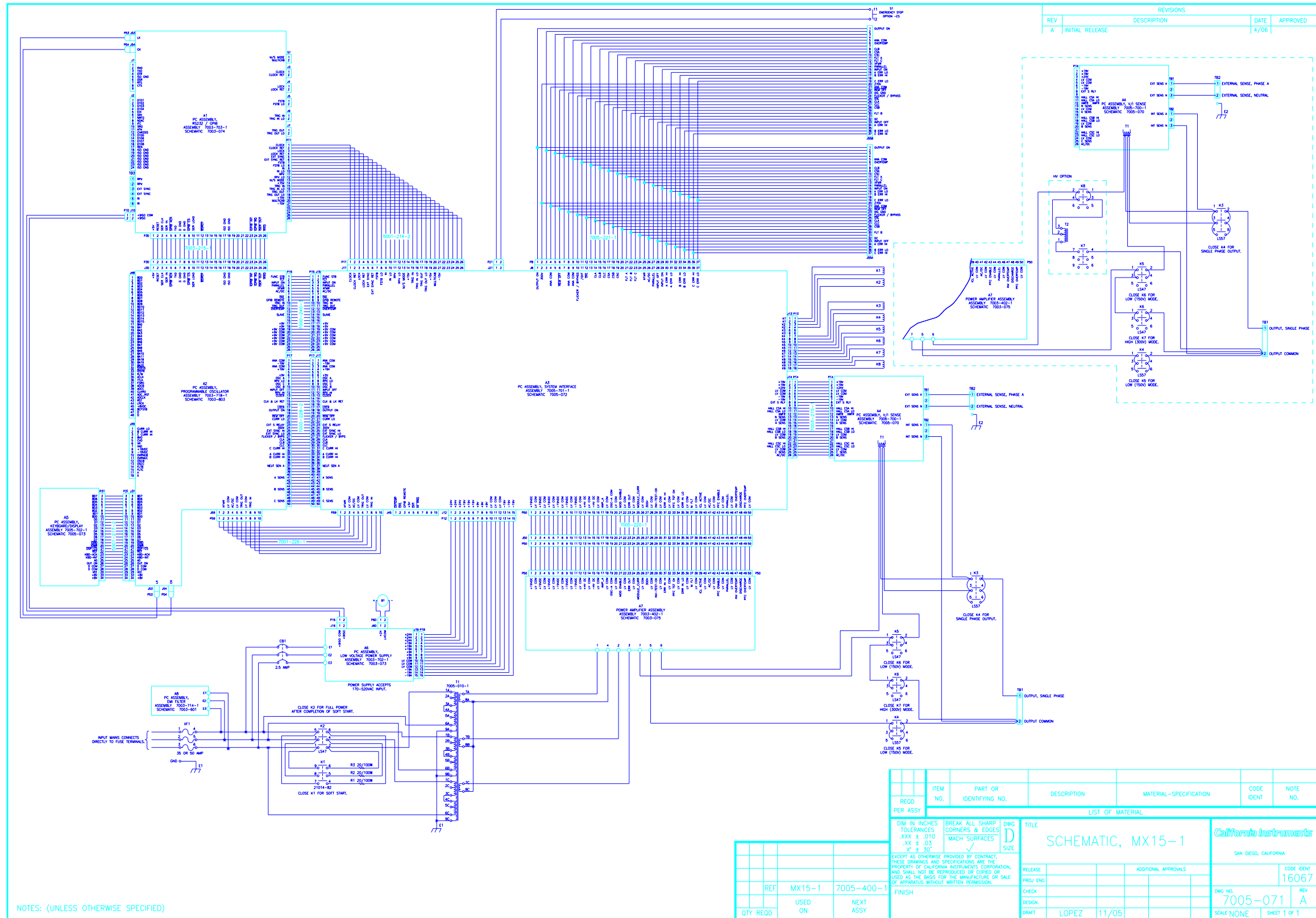

Figure 5-2: MX Series Detailed Block Diagram

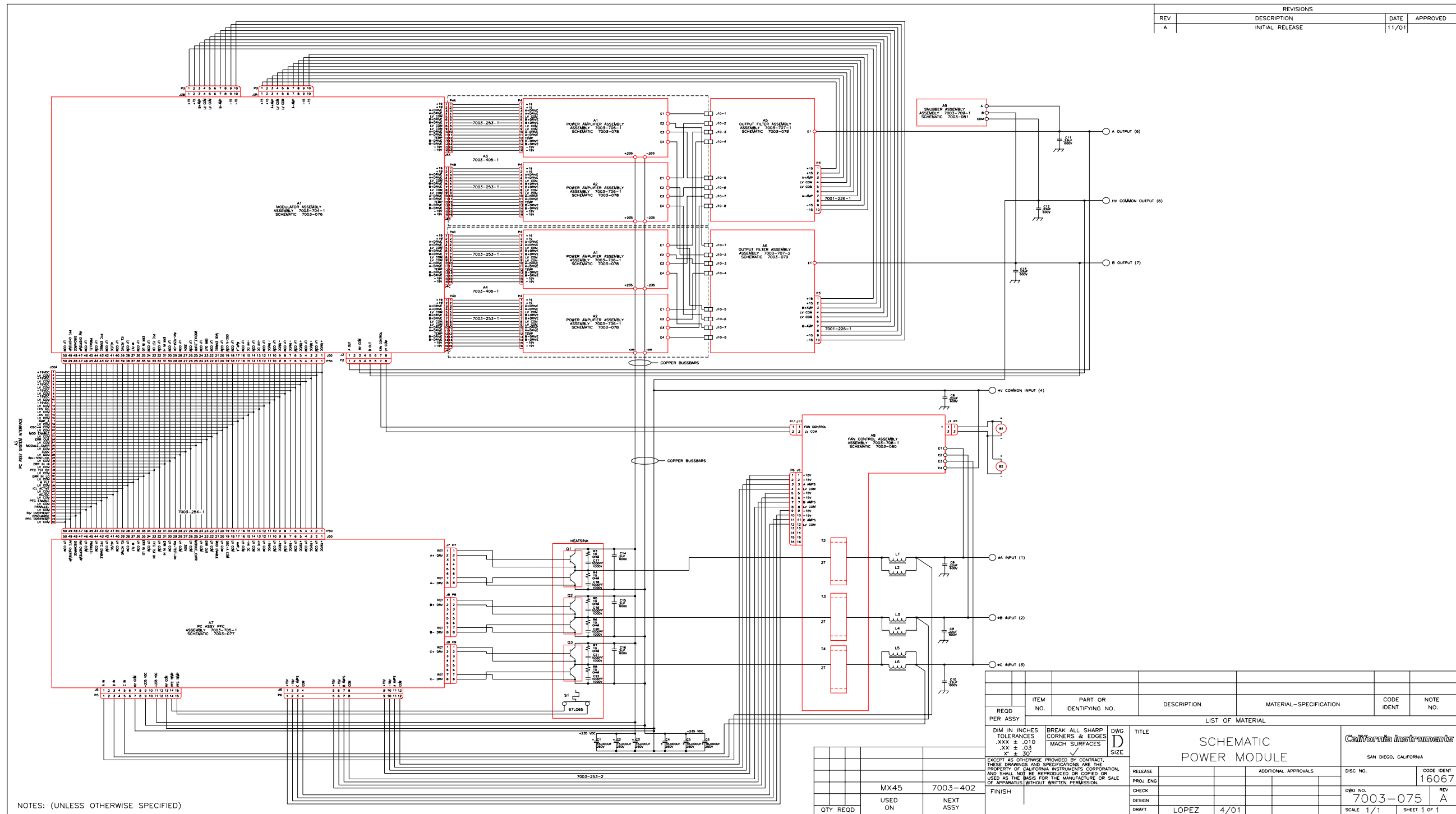

Figure 5-3: Power Module Detailed Block Diagram

5.4 System Interface Board

The System Interface Board is located in the top section of the MX15 unit. To access this assembly, the top cover needs to be removed. The System Interface board, A3, receives the oscillator signal from the CPU controller assembly for all phases and passes it through to the amplifier whose gains are controlled by a signal from the over current circuit. The over current circuit senses the RMS value of the current. If the load current exceeds the programmed value, the output of this sensing circuit reduces the amplitude of the oscillator drive signal. The output of the unit then becomes a constant current output, with the output voltage dropping as the load increases.

The System interface also monitors a variety of status signals from the amplifiers. This includes PFC good, over temperature signals and DC bus regulation good signals. If any status signal is false, the system interface board will shut down the MX. At power on, all status signals have to return good (TRUE) or the MX system power up sequence will be halted.

Finally, the System interface assembly also routes the required system interface bus signals between multiple MX15 chassis for multi-box configurations (MX30/2 and MX45/3). A DB-37 to DB-37 system interface cable is used to connect two or more MX15 units in a multi-box configuration. Each MX15 provides two sets of system interface connectors on the rear-panel. One is the master out (unit with CPU controller assembly installed), the other the Auxiliary in. ((unit without CPU controller or with CPU controller disabled.) The CPU controller can be disabled using the internal DIP switch located on the GPIB / RS232C / USB IO assembly. (Requires removal of the top cover).

5.5 Current / Voltage Sensor Board

The current and voltage sensor board, A4, senses the output current and voltage of the amplifier and feeds this information back to the system interface board. These same signals are also used by the controller for all measurement functions. Voltage sense is accomplished either internally or externally. For best voltage regulation at the EUT, external sense connections should be made using the External Sense terminal block located at the top of the back-panel.

Alternatively, internal sense mode may be selected. In this case, the voltage is sensed at the sensor board.

5.6 Low Voltage Power Supply

The Low Voltage power supply is mounted beside the system interface board in the top section of the MX15 chassis. This assembly generates all required low voltage DC outputs. These outputs from the LV Power supply provide analog and logic power to all the modules.

- a) +/- 19 V to the System Interface board and power modules.
- b) + 9 V to the oscillator.
- c) + 24 V to all contactors and LV cooling fan.
- d) Isolated + 8 V for the GPIB/RS232/USB board.

Two green LED's on the system interface board are lit when the ± 15 V and ± 19 V are in regulation. If an overload condition causes the output to drop more than 10% or the output has failed, the corresponding LED will extinguish. This feature is helpful in troubleshooting the unit. See Service section 6.

5.7 Power Module

Each MX15 chassis accommodates one power module. This power module is located in the center of the chassis and can be removed from the front after removing the front cover. Each power module is fully self-contained and forms a complete AC to AC or AC to DC converter.

The power module is depicted in Figure 5-4.

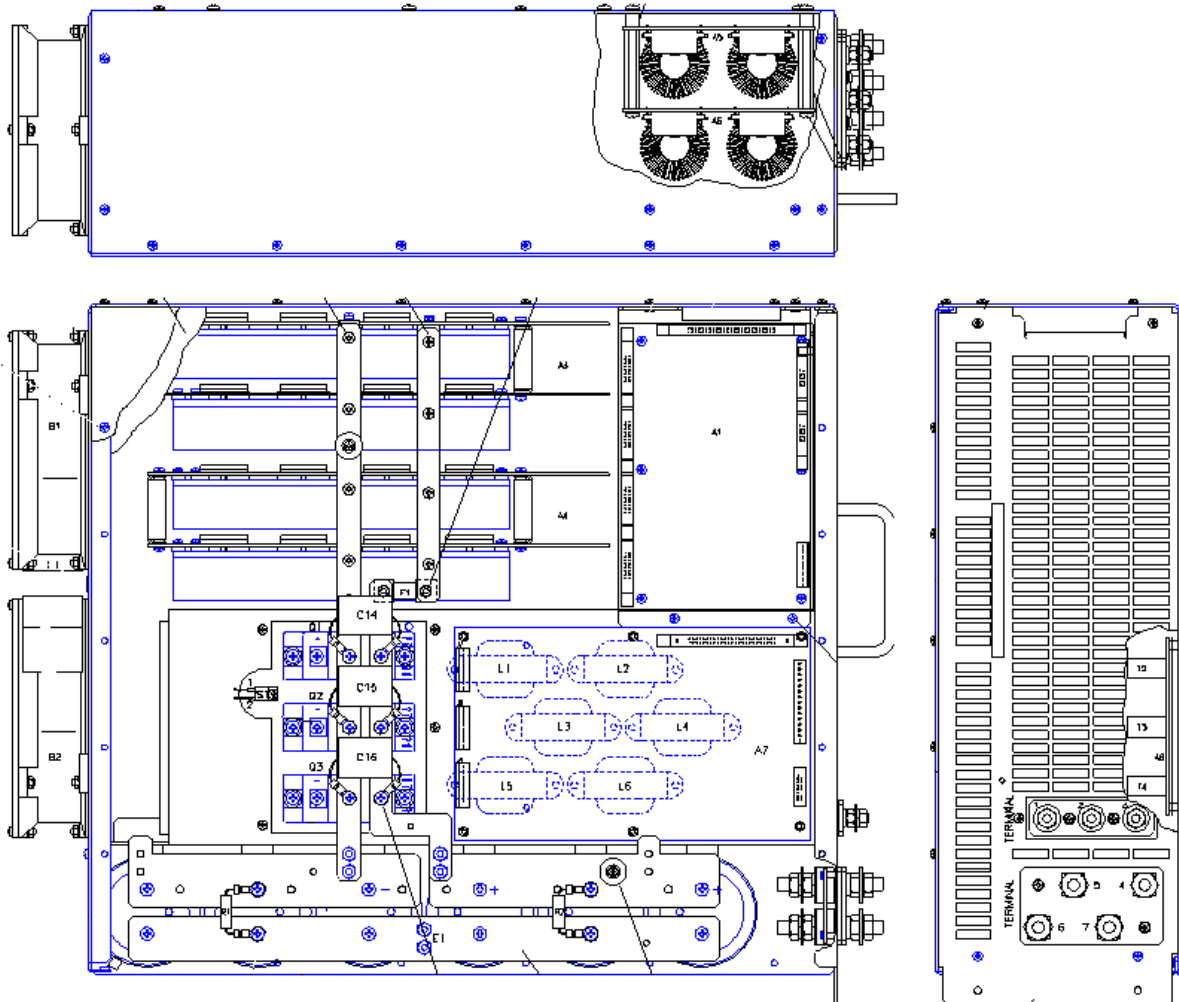

Figure 5-4: Power Module Layout

5.7.1 PFC Input Power Converter

The PFC section is located at the bottom of each power module. AC power enters the power module at the PFC input section. The PFC section using a PWM boost converter to turn the unregulated three phase 140 V AC into a regulated ± 225 V DC bus. A bank of capacitors is used to provide ride-through and to support high peak current demands from the amplifier boards. The PFC PWM circuit drives a set of three high capacity IGBT's. These IGBT's connect directly to the DC bus bars, which connect the PFC output to the Amplifier boards.

The condition of the PFC section is constantly monitored and reported to the system interface board. If the DC bus goes out of acceptable operating range, a fault is generated. Furthermore, in any of the three AC input phases fails, the MX will shut itself down.

5.7.2 Modulator Board

The modulator board is located directly above the PFC board and next to the four board Amplifier stack. The modulator board accepts an oscillator output reference signal as input and drives the four amplifier boards using a high frequency PWM technique. The modulator has the ability to drive the amplifiers in either parallel or series configuration, thus producing either a high (300 Vac / 400 Vdc) or low (150 Vac / 200 Vdc) output voltage range.

The modulator contains several feedback loops that control the current sharing and output regulation of the four power amplifier boards. The Modulator boards connect to the System interface through a 50 pin ribbon cable located at the left front of the power module.

5.7.3 Amplifier Boards

The Amplifier boards are each attached to a heat sink and stacked on top of each other at the top portion of the power module enclosure. Sets of two boards are held together by a bracket which screws into the back wall of the power module enclosure. Power to each amplifier board is supplied from the PFC section through a set of DC bus bars. Each amplifier board connects to the modulator board via a small ribbon cable. Each Amplifier board has four outputs (A+, A-, B+ and B-). These four outputs connect to a set of Inductor boards using stranded wires with Anderson style connectors. The connection between the Amplifier boards and the Inductor boards is specific and should not be reversed or damage could result. The output wire connectors of each amplifier board are color coded to help identify the correct connections. The connections between the Modulator board and the Amplifier boards are one to one. (Connectors line up with amplifier boards).

The layout of the Amplifier board is shown in Figure 5-5.

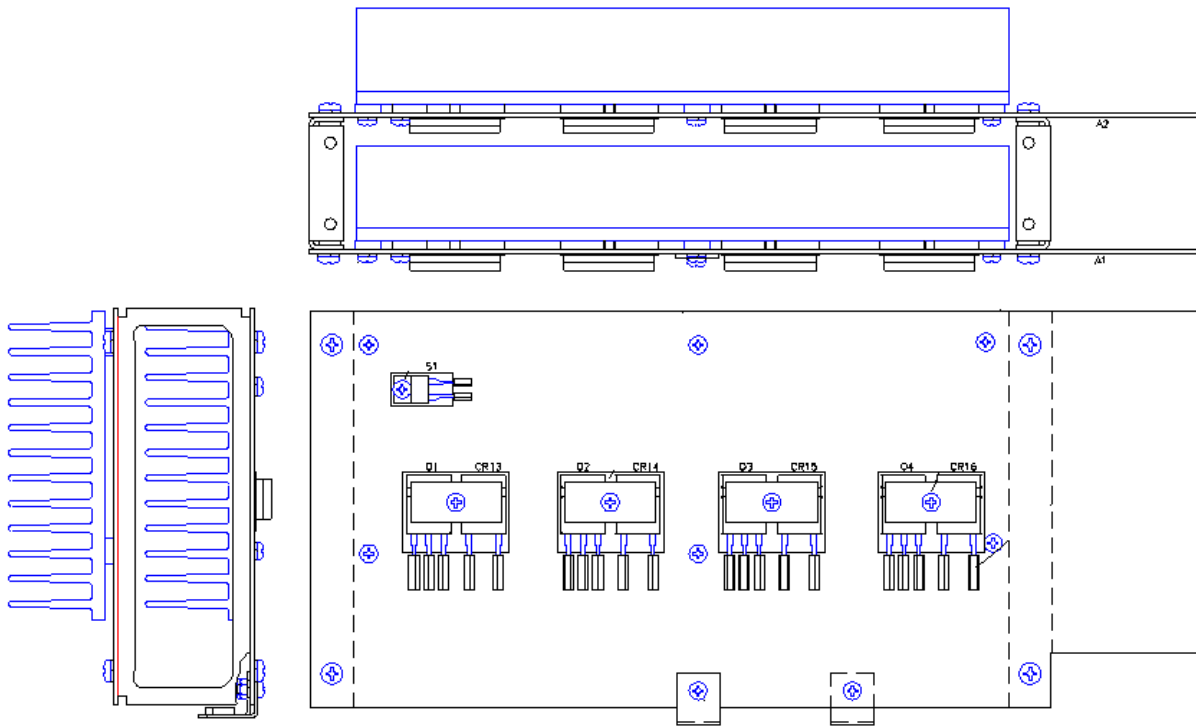

Figure 5-5: Amplifier Board Layout

5.7.4 Filter Boards

A set of two identical inductor boards is located behind the Modulator board and next to the four amplifier boards. One filter board handles the "A" output, the other handles the "B" output. In addition to the filtering function performed by these boards, the inductor boards also contain current sensors that are used in the feedback loop of the amplifier. The output of these current sensors is routed to the modulator board to regulate current sharing and peak current limiting.

5.7.5 Fan Supply Board

The Fan Supply board is located in the wind tunnel of the PFC section at the bottom of the power module. This board provides variable speed control for the dual fans of the power module. Fan speed is a function of the load current sensed. This provides for lower levels of audible noise during minimal load conditions.

5.7.6 Output Snubber Board

A small output snubber board is attached to the output terminals of each power module. This snubber provides the required operating stability of the amplifiers.

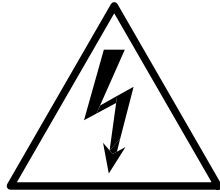

CAUTION

VOLTAGES UP TO 480 VAC AND 500 VDC ARE PRESENT IN CERTAIN SECTIONS OF THIS POWER SOURCE. THIS EQUIPMENT GENERATES POTENTIALLY LETHAL VOLTAGES.



DEATH

ON CONTACT MAY RESULT IF PERSONNEL FAIL TO OBSERVE SAFETY PRECAUTIONS. DO NOT TOUCH ELECTRONIC CIRCUITS WHEN POWER IS APPLIED.

6 Calibration

The Routine Calibration should be performed every 12 months. Non-routine Calibration is only required if a related assembly is replaced or if the periodic calibration is unsuccessful. Calibration of the MX system can be performed from the front panel or over the bus. The MXGUI program provides several calibration screens for this routine calibration but not for non-periodic calibration. This section covers calibration from the front panel. Refer to the MXGUI on line help for information on using the MXGUI program to perform routine calibration.

Full-scale output calibration is done using the internal measurement system. As such, it is important to calibrate the AC and DC voltage measurements before performing an AC and DC full-scale output calibration.

Note: *Perform the Measurement calibration first.*

The cardinal calibration points used during calibration are chosen to obtain optimal performance at the typical operating points of the MX Series. If the typical application in which the MX system is used is unusual, it may be better to calibrate it at different operating points than the ones used in this manual. Also, if the required load values for current calibration are not available, the programmed voltage may be adjusted to obtain the approximate current (typically close to maximum available current per phase).

6.1 Recommended Calibration Equipment

Digital Multimeter:	Fluke 8506A or equivalent / better. HP 34401A or equivalent / better
1 mOhm Current Shunt:	Isotek Model RUG-Z-R001-0.1.
Load Bank:	Various high power load resistors or a resistive load bank will be needed. (E.g. Avtron) Size of the load bank depends on model and phase mode. A load is required to perform the current measurement calibration near full scale. Current measurement calibration should be done on the lowest available voltage range. The accuracy and value of the load resistor is not critical as long as the current drawn is sufficient to operate the AC Source in the upper current range (80-100 %). Suggested values of load bank settings are shown in Table 6-1.
PC with CI MXGUI:	Optional.
<i>For MX15-1Pi programmable Impedance calibration only:</i>	
Digital Phase Meter:	<i>Krohn-Hite model 6610 or 6620 (GPIB) or equivalent. 0.02° accuracy, 0.01° resolution or better.</i>

6.2 Front Panel Calibration Screens

The calibration screens for output or measurement calibration can be selected from the OUTP CAL and MEAS CAL screens.

To select the OUTPUT CALIBRATION screen press ENTER on the OUTP CAL field. This will bring up the CAL PWORD screen. To prevent unauthorized access to calibration data, a password must be entered to access any calibration screen. The calibration password is always **"5000"** and may be entered using the numeric keypad. Once entered, the calibration screens remain accessible until the MX unit is powered down.

Type 5000 and press the ENTER key to show the OUTPUT CALIBRATION screen.

To select the MEASUREMENT CALIBRATION screen, follow the same steps as outlined above but select the MEAS CAL entry instead of OUTP CAL. If another CALIBRATION screen has been accessed since power-up, no password is needed. Otherwise, enter the same password as indicated above.

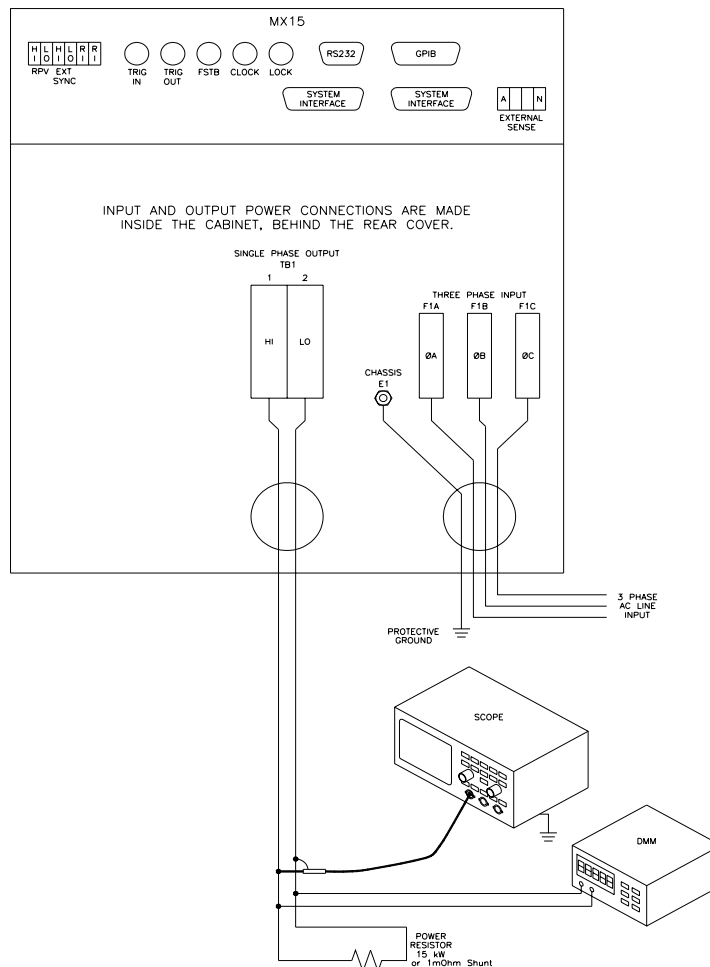

Figure 6-1: Calibration Setup MX45-1 (Rear view)

6.3 Routine Measurement Calibration

The MX Series controller measures voltage and current by digitizing both voltage and current waveforms on each available output phase. This data is subsequently processed and used to calculate all measurement parameters such as VRMS, IRMS, Power, VA, Frequency etc. To calibrate all measurements, only the voltage and current measurement need to be calibrated specifically. All other measurements are derived from these.

Connect the test equipment to the power source as shown in Figure 6-1. If the power system is a multi-cabinet system with one controller, the DVM for calibrating the measurement voltage should always be connected to the Remote Sense connector on the Master cabinet.

Note: *The Fluke 8506A Digital Multimeter must be used for the following calibration. The 8506A must be set to the AC HI ACCUR mode for all AC measurements.*

The shunt must be connected to the power source as shown in Figure 6-1. If the Current Measurement can't be successfully performed, adjust the Current Measurement Pot on the System Interface board. This adjustment is described in the Non-routine Calibration section of this manual. If the DC current measurement displays more than 70 counts on the display, perform the non-routine current monitor adjustment.

Connect the load to the output. Use the 1 mOhm current shunt in series with the load to measure the AC and DC load current. When programming a DC load always program the output voltage to 0 volts before changing the output load. This will prevent load switch contacts from being damaged.

To calibrate all measurement functions, the desired value for the measurement value of current or voltage must be entered for the corresponding calibration value. Make the indicated adjustments by typing in the desired display value. This should be the value indicated by the external DVM. If a 1 mOhm current shunt is used for current, 30 mV represents 30 amps.

The Calibration Load Table shows required load bank settings for the current measurement calibration procedure. The following text is a detailed explanation of the procedure.

Note that the voltage measurement calibration is only required on the high voltage range. The same voltage measurement calibration coefficients are used on both voltage ranges.

Note that the current measurement calibration is only required on the low voltage range – maximum available current range. The same current measurement calibration coefficients are used on both voltage ranges.

PARAMETER	POWER SYSTEM		
	MX15-1 / MX15-1Pi	<u>MX30/2-1(Pi)</u>	<u>MX45/3-1(Pi)</u>
Model ---> Lowest Range			
<u>150 VAC / 200 VDC</u>			
AC Current Full Scale	1.0 Ω , 14.4 kW	0.5 Ω , 30KW	0.33 Ω , 44 kW
DC Current Full Scale	2.67 Ω , 9.6.kW	1.33 Ω , 7.5KW	0.9 Ω , 28.5 kW
<u>300 VAC / 400 VDC</u>			
AC Current Full Scale	4.0 Ω , 14.4 kW	2.0 Ω , 30KW	1.2 Ω , 44 kW
DC Current Full Scale	10.67 Ω , 9.6.kW	5.3 Ω , 7.5KW	3.6 Ω , 28.5 kW

Table 6-1: Calibration Load Values

6.3.1 Measurement Cal

AC Volt Full-scale:	<p>Program the output to the 300 VAC range. Close the output relay. Program the output to 240 VAC and 60 Hz. Go to the MEASUREMENT CALIBRATION screen. Enter the actual AC output voltage for the VOLT FS parameter and press the ENTER key. Save this value by pressing the SET key.</p> <p>Note: This process may take as long as a few <i>minutes</i> to complete after the enter key is pressed.</p>
AC Current Full-scale:	<p>Apply a load to the output. Refer to Table 6-1. Program the output to 120 VAC on the 150 VAC range and 60 Hz. Observe the actual output current and enter this value for the CURR FS parameter. Press the ENTER key. Save this value by pressing the SET key.</p>
DC Volt Full-scale:	<p>Program the output to the 400 VDC range. Close the output relay. Program the output to 320 VDC. Go to the MEASUREMENT CALIBRATION screen. Enter the actual AC output voltage for the VOLT FS parameter and press the ENTER key. Save this value by pressing the SET key.</p> <p>Note: This process may take as long as a few <i>minutes</i> to complete after the enter key is pressed.</p>
DC Current Full-scale:	<p>Apply a load to the output. Refer to Table 6-1. Program the output to 160 VDC on the 200 VDC range. Observe the actual output current and enter this value for the CURR FS parameter. Press the ENTER key. Save this value by pressing the SET key.</p>

6.3.2 Measurement Calibration Summary

The following Table is a summary of the preceding calibration steps. The value indicated by the External DVM is called V_{AC} or V_{DC} . The current measured by the current shunt is called I_{AC} or I_{DC} .

TITLE	PROGRAM/LOAD PARAMETERS	PARAMETER	ADJUST TO
AC MODE			
AC Volt Full-scale	300 VAC Range, 240 VAC, 60 Hz, no load	VOLT FS	V_{AC}
AC Current Full-scale	150 VAC Range, 120 VAC, 60 Hz, full load to 90% of max current range.	CURR FS	I_{AC}
DC MODE			
DC Volt Full-scale	400 VDC Range, 320 VDC, no load	VOLT FS	V_{AC}
DC Current Full-scale	200 VDC Range, 160 VDC, full load to 90% of max current range.	CURR FS	I_{AC}

Table 6-2: Measurement Calibration Table

6.4 Routine Output Calibration

For best results, it is recommended to perform the measurement calibration procedure first. See section 6.3.

Follow the steps outlined in this section to perform a routine output calibration. Table 6-3 shows the individual calibration points in a summary format. The following text is a more detailed explanation of the procedure.

Setup:

Connect the test equipment to the power source depending on model configurations as shown in Figure 6-1. Note that no load is required for output calibration.

6.4.1 Output Cal

- 300 VAC Range DC Zero: Program the output to the 300 VAC Range by pressing and selecting the 300 Range with the shuttle. Go to the OUTPUT CAL screen, select the VOLT ZERO parameter and adjust the output to 0.0 ± 0.005 VDC. **Save this value by pressing the SET key.**
- 300 VAC Range Volt Full-scale: Program the output to 240.0 volts and 60 Hz. Once the output settings are made, turn on the ALC mode and allow the output on all phases to settle. Next, proceed to the output calibration screen. Select the VOLT FS parameter and enter the set voltage in the full-scale calibration window followed by the ENTER key. **Save this value by pressing the SET key.**
- 400 VDC Range Volt Zero: Press the PROGRAM key. Press the PROGRAM key and select the 400 VDC Range. Program 0.0 VDC. Go to the OUTPUT CAL screen and adjust the VOLT ZERO for 0.0 ± 0.005 volts DC on the output. **Save this value by pressing the SET key.**

6.4.2 Output Calibration Summary

The following Table is a summary of the preceding calibration steps. Note that Series II MX models have fewer calibration coefficients.

Program the following values in the table and make the adjustments in the OUTPUT CALIBRATION screen. Select the phase to be calibrated by pressing the PHASE key.

TITLE	PROGRAM VALUES	CALIBRATION VALUE	ADJUST TO
300 VAC range DC Zero	300 VAC range, 0.0 V	VOLT ZERO	0 ± 15 mV DC
300 VAC range Volt FS	240.0 V, 60 Hz	VOLT FS	240 ± 0.05 VAC
300 VDC range DC Zero	400 VDC range, 0.0 V	VOLT ZERO	0 ± 15 mV DC

Table 6-3: Output Calibration Table – MX15 Series

6.5 Non-Routine Calibration

The non-routine calibration may involve removing the front, rear, or top cover of the power source. Use extreme caution when performing any of these tasks while the system is connected to AC mains and/or powered up.

6.5.1 Power Source Gain Adjustment

For any MX configuration that requires two or more amplifiers to be operated in parallel for increased current output, the amplifier gains have to be matched as closely as possible to ensure equal current sharing. If an unbalance exists between amplifier outputs, one or the other amplifier will deliver more current and may run into its current limit protection before full output power can be attained.

This procedure details the gain adjustment. Generally, MX units are shipped with the gains already set correctly so this task should only be undertaken if an amplifier has been replaced or if two MX units are to be combined that were not originally shipped from the factory as such. In the case of the MX15, this will only be necessary if a second or third MX15 is purchased and will be added in parallel to another MX15.

To make this adjustment the front cover must first be removed in order to get access to the power module output terminals. Proceed as follows:

1. Shut off all power to the cabinets. Disconnect the two wires going to Terminal 6 and Terminal 7 on the right front of the power module. Do this to the module(s) in the auxiliary cabinet(s) only. Place some temporary insulation over the lug ends.
2. Connect a DMM between terminals 6 and 7 on the module in the **master cabinet**. Power up the cabinet. Set the controller to the 300V range, program 230V at 60Hz. Enable the output by pressing the OUTPUT ON/OFF key. Measure the module output voltage and write it down. Press the OUTPUT ON/OFF key to disable the output.
3. Move the DMM leads to the module terminals 6 and 7 in the **auxiliary cabinet**. Press the OUTPUT ON/OFF key again to enable the output. Verify the module output is within 50mVolts of the module in the master cabinet. If it is not, adjust the pot behind the hole in the lower left corner of the module so the output matches the master output within 50mVolts. Press the OUTPUT ON/OFF key to disable the output.
4. If power system under adjustment is an MX45/3, then repeat step 3 above for the second auxiliary cabinet.
5. Power down system and replace the wires to terminals 6 and 7 on the auxiliary power module(s).

6.5.2 Output Impedance Calibration (MX15-1Pi only)

For the output impedance calibration, two HP 34401A DMM's or equivalent must be used. The following modes must be programmed: 6 digits, AC Filter, slow: 3 Hz and 6 digits. One DMM is used to measure the output voltage, one to measure the load current using a suitable CT. The calibration should be done for each phase individually. Furthermore, an accurate phase meter with at least 0.01° resolution is needed. (See equipment list section 6.1). The reference input of the phase meter must be connected to the LOCK output of the controller at the rear panel. This is a square wave TTL signal. The input of the phase meter must be connected at the output of the phase being calibrated. The phase meter is used to determine the phase shift between no load and full load conditions ($\Delta\Phi$).

1. Program the power source to 230.0VAC and 50Hz. Turn off the ALC mode from the CONTROL screen. The ALC must be off to use programmable impedance.
2. Program the output impedance resistance and inductance to the lowest values from the CONTROL screen. This will be the IMP. REAL MIN and IMP. REACT MIN values that have been set in the OUTPUT CAL screen.
3. Measure the output voltage of the power source with no load and record this value (V_{NL}).
4. Using a resistive load bank, load the output of the power source to about 48 ± 9 amps. Measure the output voltage of the power source under load and record this value (V_L). Also measure the load current and record this value. (I).
5. Calculate the resistive and inductive component R and L using the formulas shown in Table 6-5.
6. Enter these values, in the OUTPUT CAL screen for the IMP. REAL MIN and IMP. REAC MIN value respectively. Make sure the correct phase is selected or use the PHASE key if not.
7. Remove or turn off the load.
8. From the CONTROL screen, select OUTPUT IMPEDANCE. Program the output inductance to 200 uH and the resistance to 200 mOhms.
9. Select the Calibration, Output screen and move the cursor to the IMP REAL FS field. Measure the R and L by removing and applying the load as described before and calculating the R and L using the formulas in Table 6-4. Adjust the resistive output impedance using the shuttle until the measured output is as close as possible to 200 mOhm. Do the same with the IMP REACT FS field. Note that the adjustment range for R is 0 to 100, for L is 0 to 300.
10. Press SET to save the calibration coefficients.
11. If there is not enough range in the full-scale calibration coefficient for either resistive or inductive portion, it may be necessary to tweak the adjustment pots on the MX controller. These pots were originally adjusted at the factory and normally do not have to be adjusted again. The Full Scale calibration coefficients should have enough adjustment range. Double check the connections and phase measurements if this is not the case to make sure the measurement readings you get are indeed correct. If it is necessary to adjust the pots, see Table 6-4 for the corresponding pot designators. The

top cover has to be removed to access these pots. They are located along the top edge of the controller board.

MX15	R resistive	XI inductive
Controller (7003-718-5)	R121	R122

Table 6-4: Programmable Z adjustment pots

Definitions:

V_{NL} = Measured RMS voltage under no load.

V_L = Measured RMS voltage under load

I = Measured RMS current.

F = Source frequency (50 Hz).

$\Delta\Phi$ = Phase angle shift between load and no load conditions. Record phase angle from phase meter under NL and L condition and determine phase shift.

Formulas to calculate R and L component of output impedance:

$$R = (V_{NL} * \cos(\Delta\Phi) - V_L) / I$$

$$X_L = (V_{NL} * \sin(\Delta\Phi)) / I$$

$$L = X_L / (2 * \text{Pi} * F)$$

Table 6-5: Formulas to calculate R and L

7 Service

7.1 Cleaning

The exterior of the power source may be cleaned with a cloth dampened with a mild detergent and wrung out. Disconnect mains power to the source before cleaning. Do not spray water or other cleaning agents directly on the power source.

7.2 General

This section describes the suggested maintenance and troubleshooting procedures. The troubleshooting procedure is divided into two sections. The first section deals with basic operation and connection of the equipment. The second section requires opening the unit and using LED indicators and a simple multimeter to troubleshoot the unit down to the module level. Only a qualified electronic technician should attempt this level troubleshooting.

7.3 Basic operation

Table 7-1: Basic Symptoms

PARAGRAPH	PROBLEM
7.3.1	Excessive Output Voltage
7.3.2	Poor Output Voltage Regulation
7.3.3	Overload Light On
7.3.4	Distorted Output
7.3.5	Unit Shuts Down After 1-2 Seconds
7.3.6	No Output and no lights on front panel
7.3.7	No output, but front panel controller is active.

7.3.1 Excessive Output Voltage

CAUSE	SOLUTION
External sense not connected (If used)	Connect external sense wires from TB2 on rear panel to the AC power outlet TB1

7.3.2 Poor Output Voltage Regulation

CAUSE	SOLUTION
Unit is overloaded	Remove overload
Unit is programmed to wrong voltage range.	Select correct voltage range.
Input line has fallen below spec limit.	Check input supply voltage.

7.3.3 Overload Light is On

CAUSE	SOLUTION
Unit is overloaded	Remove overload or check CL setting
Unit is switched to high voltage range.	Select correct voltage range.

7.3.4 Distorted Output

CAUSE	SOLUTION
Power source is grossly overloaded.	Reduce load
The crest factor of the load exceeds 3:1 on the low range or 5:1 on the high range.	Reduce load current peaks by reducing load.

7.3.5 Unit Shuts Down after 1-2 Seconds

CAUSE	SOLUTION
Output shorted	Remove output short
Output grossly overloaded.	Remove overload.
PFC IGBT module failure	Have power module serviced
Operating load with too high inrush or start up currents.	Consult factory for application advice.

7.3.6 No Output and No Lights on Front Panel

CAUSE	SOLUTION
Input circuit breaker switched off.	Switch the breaker on.
No input power to F1, F2 and F3.	Ensure 3 phase power is getting to input fuses.
LV Power Supply failure	Have LV supply serviced.

7.3.7 No Output But Front Panel controller is active

CAUSE	SOLUTION
“OUTPUT ON” button is turned off.	Press OUTPUT ON so that “ON” LED is lit.
REMOTE INHIBIT pins 5 & 6 at TB3 on rear panel are shorted together.	Check polarity setting or RI Mode. Use OUTPut:RI[:LEVel] LOW/HIGH command to set RI mode to high or low.
Current limit programmed down or to zero.	Program current limit higher.
Voltage programmed down or to zero.	Turn amplitude control up.

7.4 Advanced Troubleshooting.



WARNING: Do not connect 400-480V into the 208-240V unit, the result could be a severely damaged unit.



CAUTION: VOLTAGES UP TO 480 VAC AND 450 VDC ARE PRESENT IN CERTAIN SECTIONS OF THIS POWER SOURCE.



WARNING: THIS EQUIPMENT GENERATES POTENTIALLY LETHAL VOLTAGES. DEATH ON CONTACT MAY RESULT IF PERSONNEL FAIL TO OBSERVE SAFETY PRECAUTIONS. DO NOT TOUCH ELECTRONIC CIRCUITS WHEN POWER IS APPLIED

7.4.1 Switch Off Unit

Switch off the unit at the circuit breaker on the front panel as well as removing the input power from the unit.



WARNING: Wait 10 minutes for all internal capacitors to discharge.

7.4.2 Removing Covers

Remove the screws securing the rear cover and remove it

Remove the screws securing the front cover and remove it.

Remove the screws securing the top cover and remove it.

7.4.3 Initial Inspection

Make a visual inspection of the unit and ensure all the connectors are properly mated and there are no loose wires.

7.4.4 Fuse Check

Using an ohmmeter, check input fuses F1, F2 and F3 for continuity.

7.4.5 Power-on Troubleshooting Using the LED's.



WARNING: *Do not touch any parts inside the unit during this test as they will be live and dangerous. Always wear safety glasses.*

If the three input fuses are OK, then reconnect the main AC input power to the cabinet.

LV Supply (CI P/N 7003-702):

Turn the main breaker on and check green LED DS2 and DS3 on the system interface board. Both LEDs should be lit indicating the +/-19Vdc and +/-15Vdc supplies are OK.

If one or both of the LEDs is not lit, then there is something wrong with the LV power supply and it will have to be serviced.

Oscillator (Front Panel):

If LV supply appears good, then program 150Vac on the low range and connect a DMM to TP2 (phase A) on the system interface board with the low side of the meter connected to TP1. There should be a 2 – 3 volt rms signal present on TP2.

AC power module (CI P/N 7003-402-1):

If the oscillator drive signals are present on the system interface board, connect the DMM to brass terminals 5 & 6 located near the bottom of the power module. Program 100 Volts.

There should be about 100Vac between terminals 5 and 6. If no voltage at all is measured it is possible that the AC power stage inside the module has failed and it will be necessary to remove the power module from the chassis for closer inspection.



WARNING: *Wait 10 minutes for all internal capacitors to discharge.*

To remove the power module proceed as follows:

1. Disconnect the 7 wires going to the brass terminals on the lower front panel of the module. Label the wires so they can be reinstalled correctly later.
2. Remove screws securing the upper and lower straps holding the module in the chassis slot.
3. Remove the 50-pin ribbon connector at J50.
4. Carefully slide module outward and lift out of cabinet. Use caution, module weighs 66 LBS (30Kg).
5. With the power module out of the cabinet and lying flat on a bench, remove the screws on the bottom and sides of the cover as seen from the front when module is installed normally.
6. Inspect the three IGBT transistor modules Q1, Q2 and Q3 for any visible damage.
7. Using an ohmmeter check the 30A fuses on the positive and negative side of the power distribution board that connects the four amplifier modules to the DC bus. If any of them are open, then one or more of the amplifier sections has a damaged device on the heat sink assemblies and the power module assembly will have to be serviced.

7.4.6 Other No Output Conditions

If one or more outputs is gone, it may be caused by an amplifier failure. Amplifier failures can either be input (PFC) or output related (Amp). To determine if this is the case, the cover of the

amplifier has to be removed. Contact customer service support@calinst.com before attempting to diagnose on your own.

PFC failure denotes one or all three of the IGBT power modules on the large PFC heat sink have shorted, and damaged the devices. This type of failure is sometimes accompanied by a popping sound as the large PFC power devices give out. To diagnose this failure mode, the amplifiers must be removed and the cover removed for inspection.

If there is any sign of damage, the PFC power devices must be replaced. If not, they need to be checked for continuity using a DMM or diode checker.

In case of a PFC failure, older generation PFC control boards (7003-705 or 7003-712) may have sustained damaged in the isolated gate drive section of the board and the board itself may have to be replaced. MX Systems with later generation 7003-716 PFC control boards generally will only require replacement of the 2A gate fuses to restore functionality.

If the PFC section looks intact, one of the output amplifier switches may have shorted.

The usual scenario is one or two of the IGBT switch devices on one of the 4 heat sinks get shorted. Usually if the B+ device is failed, the B- device will also short. When these devices short, one or more of the 30A fuses (F1 through F8) on the DC power distribution board will be open.

An amplifier device failure is not audible at all so there may be no indication of this other than checking as follows:

1. Measure the output voltage with Zero AC volts programmed.
2. Remove any EUT from the output connections.
3. Turn output ON and measure the AC and DC output. It should be close to zero.
4. If the output reads -225VDC on the low range and close to 0 Vdc on the high range, then it is almost certain that the fuse is blown and 1 or 2 IGBT devices are shorted.

Note that the measurement screen will not report the DC faulty output voltage in the AC mode, as the measurements in this mode are AC coupled. Therefore, it is necessary to measure at the output terminals with a DMM to determine the actual output. Alternatively, the MX45 can be switched to AC+DC mode in which case the internal measurements can be used instead.

If it is determined that it is an amplifier failure, the affected IGBT's need to be replaced. If no local service support is available, the amplifier may be exchanged completely. Contact customer service support@calinst.com for module exchange information.

7.5 Factory Assistance

If the problem with the cabinet or one of the power modules cannot be isolated, contact the factory for assistance.

7.6 Fuses

FUSE #	FUNCTION	FUSE VALUE	CI #
F1, F2, F3	AC mains input, 208 - 240V.	60A	270247
F1, F2, F3	AC mains input, 400 - 480V	35A	270244
F1	Power Module PFC Fuse	70A	270233
F1 – F8	AMP Heat Sink Fuses	30A	270168

Table 7-2: MX Fuse Ratings

7.7 Firmware Updates

All MX15 Series units support firmware updates over the RS232C interface.

7.7.1 Requirements

This section provides basic instructions for updating firmware on MX series AC power sources. The following items are required to download new firmware:

- A copy of the new firmware in HEX format. Typically named “cic920rn.nn.hex” where “n.nn” represents the revision of the firmware. The file may be downloaded from the California Instruments’ website (www.calinst.com) or may have been distributed through email. If the file is archived to a zip, it must be unzipped to its original HEX format (.hex extension) before it can be used.
- The FlashLoaderComm utility program is what is used to install new firmware. This Windows program can be downloaded from the California Instruments website (www.calinst.com) under GUI/Software. You need to be a registered user to do so.
- A Windows 2000/XP PC with available RS232 serial port (COM port).
- A RS232¹ serial cable, CI P/N 7000-263-2. This cable is provided in the MX15 Series ship kit. If lost, refer to the MX Series programming manual (PN 7003-961) for cable pin-out information or contact customer service (support@calinst.com) to order a replacement.

7.7.2 Download Instructions

Copy both FlashLoaderComm.exe and cic920rn.nn.hex files to a temporary folder on your PC. If the FlashLoaderComm.exe was downloaded from the CI web site, it will have to be installed. This is a self-extracting program installation. Just double click on the exe file to perform the installation and follow the user prompts.

Cic920rn.nn.exe is the hex file that contains the firmware update. The n.nn will be the revision number of the firmware. The hex file may be distributed as a WinZip archive with a .zip extension. In that case, unzip the .zip file to its native .hex format before attempting to upgrade the MX15 unit.

Please record the revision of the previous firmware before the update for reference. The firmware revision is displayed during power up sequence of the MX15 AC source.

Connect the 7000-263-2 RS232 cable (9 pin to 9 pin) between the power source and an available COM port of the PC.

¹ The GPIB interface cannot be used for this purpose, as the Flash boot loader is a small resident program that does not support GPIB communications.

Power up the AC source using its on/off switch **while holding the ENTER key at the same time**. A sequence of messages will appear on the LCD once the power comes on:

```
Firmware
Down Load Mode
```

```
Down Load Mode
User Entry
```

```
Serial Port
Setup
```

This will put the source controller into the Flash down load mode. Wait until the screen shown below appears. This screen shows the RS232 setup parameters that are used in the boot loader mode.

```
Baud 38400, Bits 8
Stop 1, No Parity
```

Now launch the Flash Loader utility program "FlashLoaderComm.exe".

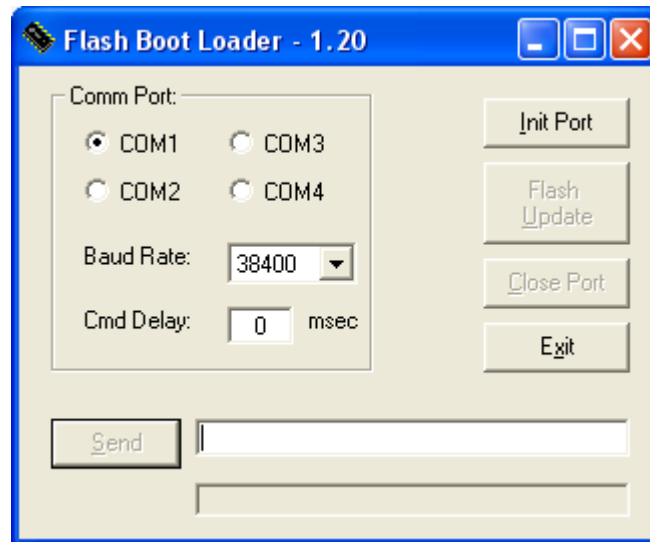

Select the COM port to be used (default is COM1). Leave "Baud rate" and "Cmd Delay" set to their default values of 38400 baud and 0 msec.

Click on the "Init Port" button. If the selected port can be initialized, the "Flash Update" button will be enabled. If not, check the selected COM port and make sure it is the one connected to the MX15.

Press the "Flash Update" button. This will display the file download screen shown below.

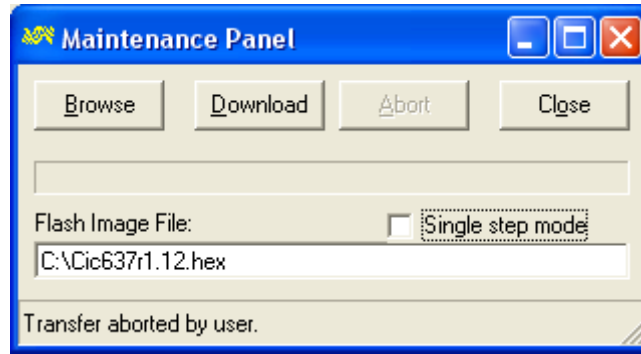

Select Browse and locate the file Cic920rn.nn.hex at the location on the PC where you stored it before.

Click on the “Download” button. This will start the firmware update procedure. The front panel display for the AC source will display the message “Erasing Flash” first, followed by “Flash erase complete” and “Programming Flash”. The download will be completed in about 5 to 10 minutes depending on the size of the .hex file.

After the download completes successfully, the power source will initialize with the new firmware. Observe the LCD display for the firmware revision displayed during initialization to confirm the new firmware is now installed.

7.7.3 Flash download Messages

One or more messages may appear during this process. The table below shows some of the possible message and their meaning.

Message	Description	Remedy
Flash erase complete	Erase operation successful.	
Flash erase fail	Firmware download capability not supported by CPU board..	Refer to Service Bulletin SB-0043
Flash write fail	Unable to write to flash. This message is unlikely as it generally is preceded by the Flash Erase Fail message.	Refer to Service Bulletin SB-0043
Firmware download fail	Data error. Incorrect checksum read-back from Flash block. Communication interrupted or problem with RS232 interface.	1. Check cable connection. 2. Try setting CmdDelay in Flash loader program to 100 msec and try again.

Table 7-3: Flash Download Messages

8 Top Assembly Replaceable Parts

Seq #	CI P/N	Description	Vendor	Qty	Location
A2	7003-718-5	CPU board assy	California Instruments	1	
A5	7005-702-1	Keyboard/Display assy.	California Instruments	1	
A3	7005-701-1	PC Assy, System Interface	California Instruments	1	
A4	7005-700-1	PC Assy, V / I Sense	California Instruments	1	
A6	7003-702-1	PC Assy, Low Volt PSU	California Instruments	1	
A14	7003-713-1	PC Assy, PWR Interconnect	California Instruments	1	
A8	7003-714-1	PC Assy, EMI Filter	California Instruments	1	
A7	7003-418-1	Amplifier Assy, 15kVA	California Instruments	1	
B1	241186	Fan, 3", 24VDC	NMB Technology 3110KLO5WB50-P00	1	
CB1	270224	Circuit Breaker, 2.5A, 300V	AIRPAX IELH111-1-61-2-50-D-01-V	1	
K1	245235	Relay, 3C, 30A, 24VDC	Deltrol Controls 21014 - 82	1	
K7	245235	Relay, 3C, 30A, 24VDC	Deltrol Controls 21014 - 82	1	
K2	245243	Relay, 3C, 90A, 24VDC	Cerus Industrial Orion CRD-50	1	
K6	245243	Relay, 3C, 90A, 24VDC	Cerus Industrial Orion CRD-50	1	
K8	245243	Relay, 3C, 90A, 24VDC	Cerus Industrial Orion CRD-50	1	
K3	245243	Relay, 3C, 100A, 24VDC	Cerus Industrial Orion CRD-50	1	
K5	245243	Relay, 3C, 100A, 24VDC	Cerus Industrial Orion CRD-50	1	
K4	245243	Relay, 3C, 100A, 24VDC	Cerus Industrial Orion CRD-50	1	
Top Assembly 7005-403					
A1	7003-721-3	PC Assy. RS232 / GPIB / USB	California Instruments	1	
A1	7003-721-4	PC Assy. RS232 / GPIB / USB / LAN	California Instruments	1	
Top Assembly 7005-400					
A1	7003-703-3	PC Assy RS232 / GPIB /W	California Instruments	1	
A1	7003-703-4	PC Assy RS232 / GPIB /Wout	California Instruments	1	

Seq #	CI P/N	Description	Vendor	Qty	Location
Amplifier Assy 15kVA 7003-418-1					
A1	7003-704-1	PC Assy, Modulator	California Instruments	1	A7
A3	7003-405-1	Heatsink Assy Amplifier	California Instruments	1	A7
A4	7003-405-1	Heatsink Assy Amplifier	California Instruments	1	A7
A5	7003-707-1	PC Assy, Output Filter	California Instruments	1	A7
A6	7003-707-2	PC Assy, Output Filter	California Instruments	1	A7
A7	7003-716-1	PC Assy, PFC	California Instruments	1	A7
A8	7003-708-1	PC Assy, Fan Control	California Instruments	1	A7
A8	7003-717-1	PC Assy, Snubber	California Instruments	1	A7
B1	241183	FAN, 6"	ROTRON JQ24B2	1	A7
B2	241183	FAN, 6"	ROTRON JQ24B2	1	A7
Q1	330436	Transistor, IGBT	IXYS, IXGX60N60C2D1	1	A7
Q2	330436	Transistor, IGBT	IXYS, IXGX60N60C2D1	1	A7
Q3	330436	Transistor, IGBT	IXYS, IXGX60N60C2D1	1	A7
Q4	330436	Transistor, IGBT	IXYS, IXGX60N60C2D1	1	A7
CR13	310387	Diode, FRcy, 30A, 1000V	APT, APT30D100B	1	
CR14	310387	Diode, FRcy, 30A, 1000V	APT, APT30D100B	1	
CR15	310387	Diode, FRcy, 30A, 1000V	APT, APT30D100B	1	
CR16	310387	Diode, FRcy, 30A, 1000V	APT, APT30D100B	1	
Q1	330437	Transistor, IGBT	FUJI, 2MBI150NC-060	1	A7-PFC
Q2	330437	Transistor, IGBT	FUJI, 2MBI150NC-060	1	A8-PFC
Q3	330437	Transistor, IGBT	FUJI, 2MBI150NC-060	1	A9-PFC

Table 8-1: Replaceable Parts

Seq #	CI P/N	Description	Vendor	Qty	Assy Number and Location
Top Assembly 7003-400-01					
F1	270247	FUSE, 60A, 600V	LITTELFUSE JLLS 60	1	} For 208V / 230V Input
F2	270247	FUSE, 60A, 600V	LITTELFUSE JLLS 60	1	
F3	270247	FUSE, 60A, 600V	LITTELFUSE JLLS 60	1	
F1	270244	FUSE, 35A, 600V	LITTELFUSE JLLS 35	1	} For 400V / 480V Input
F2	270244	FUSE, 35A, 600V	LITTELFUSE JLLS 35	1	
F3	270244	FUSE, 35A, 600V	LITTELFUSE JLLS 35	1	
Amplifier Assy 15kVA 7003-418-1					
F1	270233	FUSE, 70A, 500V	Ferraz Shawmut A50QS70-4	1	A7
F1-F8	270168	FUSE, 30A, 600V	Bussmann KTK-30 Littlefuse KLK-30	8	7003-713-1
Low Voltage Power Supply 7003-722-1					
F1	270192	FUSE, Poly switch	Raychem RUE250	1	A6
F2	270192	FUSE, Poly switch	Raychem RUE250	1	A6
F3	270189	FUSE, Poly switch	Raychem RXEF110	1	A6
Low Voltage Power Supply 7003-702-1					
F1	270192	FUSE, Polyswitch	Raychem RUE250	1	A6
F2	270192	FUSE, Polyswitch	Raychem RUE250	1	A6
Fan Control 7003-708-1					
F1	270183	FUSE, 3A, 250V	Bussmann PCC3	1	A7-A8
F2	270192	FUSE, Polyswitch	Raychem RUE250	1	A7-A8

Table 8-2: Fuses

9 Options

9.1 Introduction

There are a number of options available for the MX15 Series, both hardware and software. While not all or no options may be present on your specific unit, this section of the manual incorporates the user documentation for all available options. There is no separate manual for these options except possible manual addenda for special engineering request (SER) systems. If your system has an SER number as part of the model number, refer to any manual addendum that was shipped with the unit.

9.2 Option -HV: Additional AC Voltage Range

The -HV option provides an additional AC only output voltage range of 0-400 VRMS. There is no equivalent 200 VRMS range associated with the -HV option but the standard 0-150 V RMS and 0-300 V RMS remain available even if the -HV option is installed.

If the -HV option is installed, there will be three voltage ranges that can be selected from the PROGAM menu. (150/300/400). Other than the range values, all other operations remain the same. Note however that the -HV range is AC coupled and as such offers no DC output capability. Thus, whenever the 400 V range is selected, the output mode is automatically set to AC MODE and other modes cannot be selected.

Arbitrary waveforms

As stated before, the -HV (and -XV) range is AC (transformer) coupled and as such cannot pass any DC component from the waveform generator. This means that any arbitrary waveform created by the user that is to be used in the -HV range cannot have any DC offset. The MX firmware will generate an error message if an attempt is made to select a custom waveform with DC offset while in the -HV range.

9.3 Option –160: RTCA/DO-160 Tests

The RTCA/DO-160 Option is made up of both firmware that resides in the power source and the MXGui Windows application program. The firmware covers revision D and can be used from the front panel or under MXGui control. Revision E is implemented through the MXGui only.

The user interface for each implementation is different. The revision D tests can be operated directly from the power source's front panel or through the supplied MXGui program. The Revision E tests can only be operated through the MXGui windows software. Thus, for Rev E use, a Windows PC and interface – RS232, USB, LAN or GPIB (recommend) - is required.

Section 9.3.1 covers operation of the firmware based revision D tests.

For information regarding the operation of the DO160 revision E tests with the MXGui, please refer to the Avionics Software Manual (CI part no. 4994-971 included on CDROM). Note that future updates of the MXGui may include overlapping coverage for revision D in the software as the MXGui program is designed to support all revisions. For now, revision D has no associated data files in the MXGui but does have it's own user interface control screen.

9.3.1 Option –160: RTCA/DO160 rev D Tests (Firmware)

9.3.1.1 General

This user manual assumes that the user is familiar with the text of the relevant DO160, section 16 test standard. No attempt is made to explain or elaborate on the actual test specification.

The RTCA/DO-160D option is capable of performing all sub-sections of RTCA/DO-160D, Section 16, RTCA/DO-160D change No2 and EUROCAE-14D / RTCA DO160D, Section 16 for the AC Source signal. A selection is made available to specify the type of standard to be applied to the EUT and the available EUT groups.

The voltage modulation tests for Airbus ABD0100.8 are supported by this option as well. The voltage modulation levels for the Airbus version are specified differently from DO160. All other tests are the same for Airbus and DO160.

Throughout this document, RTCA/DO-160D change No2 will be referred to as RTCA2. Groups 1 through 3 will be used to refer to the EUROCAE-14D standard. Category A(CF), A(NF) and A(WF) will be used to refer to the RTCA2 standard.

9.3.1.2 Initial Setup

Nominal parameters for the AC Power source are as follows:

Output Voltage	115V L-N or 230V L-N
Output Frequency	360 Hz to 800 Hz

Note: *A setting outside these nominal values will disable the test and will prevent access to the DO160 Menu screens. To execute all tests for the 230V L-N, the power source must be capable of programming 360V RMS. This requires the -HV option output range (400V). If this option is not installed, some tests will be skipped.*

9.3.1.3 Tests Performed

9.3.1.3.1 NORMAL STATE

AC Source:

1. Normal State Voltage and Frequency test
2. Voltage unbalance test
3. Waveform Distortion test
4. Voltage Modulation test
5. Frequency Modulation test
6. Momentary Power Interrupt (Under voltage) test
7. Voltage Surge (Over voltage) test
8. Frequency Transients test(Group 1 only)
Frequency Variation test (Group 2 and 3 only)

9.3.1.3.2 EMERGENCY TEST**AC Source:**

1. Emergency Voltage and Frequency minimum
2. Emergency Voltage and Frequency maximum
3. Voltage unbalance

9.3.1.3.3 ABNORMAL TEST**AC Source:**

1. Abnormal Voltage minimum
2. Abnormal Voltage maximum
3. Voltage Drop
4. Voltage Surge
5. Frequency Transients test (group 1 only)

9.3.1.4 Front Panel Operation -160

To perform a test from the keyboard, Press the MENU key several times until the APPLICATIONS/OPTIONS Menu appears, select the APPLICATIONS screen. The APPLICATIONS screen will appear as shown in Figure 9-1.



Figure 9-1: Application Menu

Scroll to the RTCA/DO-160D entry using the up and down cursor keys. Press the ENTER key to select the RTCA/DO 160D main menu. The screen will appear as shown in Figure 9-2.

Note: *The user has to turn on the Output relay before starting a test.*

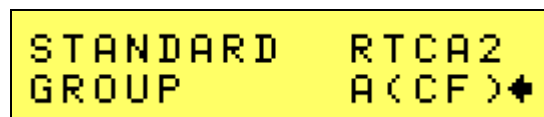

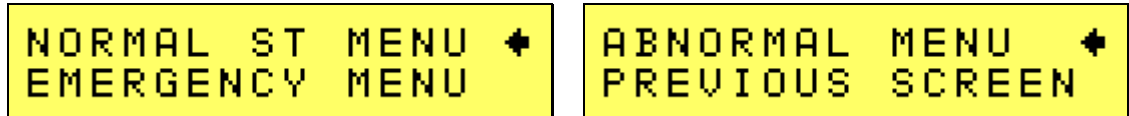

Figure 9-2: DO160 Main Menus

Prior to executing a test, selection of the desired test standard and group is required. Use the shuttle to select the standard and the group if applicable.

9.3.1.5 Normal State tests

Scroll to the NORMAL STATE entry using the up and down cursor keys. Press the ENTER key to select the NORMAL STATE screens. The screen will appear as shown in Figure 9-3.

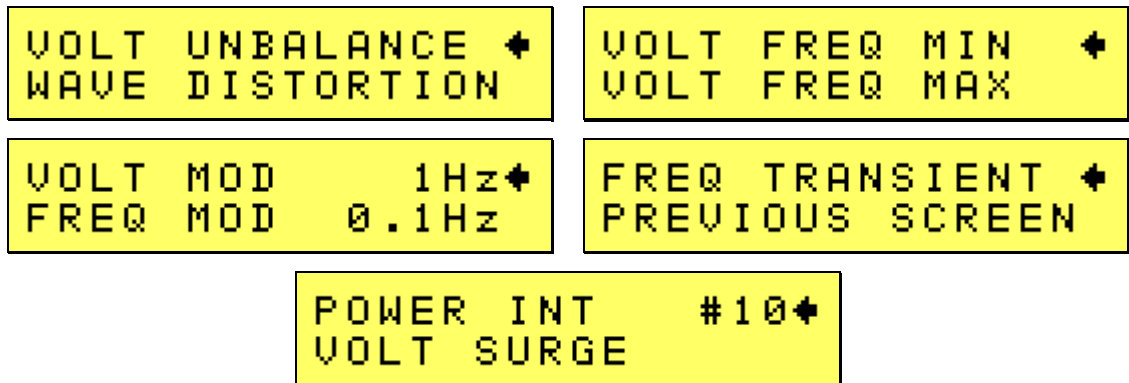

Figure 9-3: Normal state screens

The DO160 NORMAL screens have the following tests:

- 1 VOLT FREQ MIN
- 2 VOLT FREQ MAX
- 3 VOLT UNBALANCE
- 4 WAVEFORM DISTORTION
- 5 VOLT MODULATION
- 6 FREQ MODULATION
- 7 POWER INTERRUPT
- 8 VOLTAGE SURGE
- 9 FREQ TRANSIENT (group 1/A(CF))
FREQ VARIATION (group 2 & 3/A(NF) & A(WF))

The above tests can be selected by scrolling to the highlighted selection using the up and down key and the ENTER key to start the selected test. For some of these tests, numeric data entry may be required to define the test number or the modulation rate.

VOLT FREQ MIN

Standard/Group	RTCA	A(CF)	A(NF)	A(WF)
----------------	------	-------	-------	-------

Standard/Group		RTCA	A(CF)	A(NF)	A(WF)
Voltage	1	100	100	100	100
	3	N/A	N/A	N/A	N/A
Frequency		380	390	360	360

Standard/Group		Group1	Group2	Group3
Voltage	1	104	104	104
	3	N/A	N/A	N/A
Frequency		390	360	360

Table 9-1: Normal Voltage and Frequency minimum

Standard/Group		RTCA	A(CF)	A(NF)	A(WF)
Voltage	1	122	122	122	122
	3	N/A	N/A	N/A	N/A
Frequency		420	410	650	800

Standard/Group		Group1	Group2	Group3
Voltage	1	122	122	122
	3	N/A	N/A	N/A
Frequency		410	650	800

Table 9-2: Normal Voltage and Frequency Maximum

This test will set the voltage and frequency to levels defined by Table 9-1. The test will last for 30 minutes. The test will be repeated, except group1, using the Voltage setting from Table 9-2 and the frequency from Table 9-1. The ← key (backspace) will terminate the test at any time.

VOLT FREQ MAX

This test will set the voltage and frequency to levels defined by Table 9-2. The test will last for 30 minutes. The test will be repeated, except group1, using the Voltage setting from Table 9-1 and the frequency from Table 9-2. The unselected phases will remain at 115 volts. The ← key (backspace) will terminate the test at any time.

VOLT UNBALANCE

This test is not available on the MX15 Series since only a single phase output is available.

WAVEFORM DISTORTION

This test will generate a 5% THD voltage distortion on the output voltage waveform at the nominal voltage set. (115 V or 230 V) A clipped sine wave generates the required distortion. The test will last for 30 minutes. The ← key (backspace) will terminate the test at any time.

VOLTAGE MODULATION

This test requires a numeric value entry equal to the modulation rate in Hz. This entry value must be between 1 Hz and 200 Hz. The amplitude modulation is calculated based on the modulation rate as defined in Figure 9-4. This test will last for 2 minutes.

Note that the Airbus voltage modulation test levels are specified in peak to peak voltage instead of Vrms. Table 9-3 shows the levels for the Airbus mode versus the DO160 and EUROCAE modes as implemented in the MX15 firmware. The actual requirement for Airbus ABD0100.8 is now specified in Vpeak peak instead of Vrms so the Airbus mode should not be used. Use the DO160 or EURO/CAE mode instead.

Modulation Frequency (Hz)	DO160 / EUROCAE	Modulation Frequency (Hz)	AIRBUS
	Volt RMS		Volt RMS
1	0.18	1	0.5
1.7	0.18	1.7	0.5
10	1.24	10	3.5
25	1.24	25	3.5
70	0.18	70	0.5
100	0.18	100	0.5
200	0.18	N/A	N/A

Table 9-3: Airbus mode voltage modulation.

Note: Voltage modulation levels change linearly from frequency 1.7Hz to 10Hz and again from 25Hz to 75Hz. See Figure 9-4.

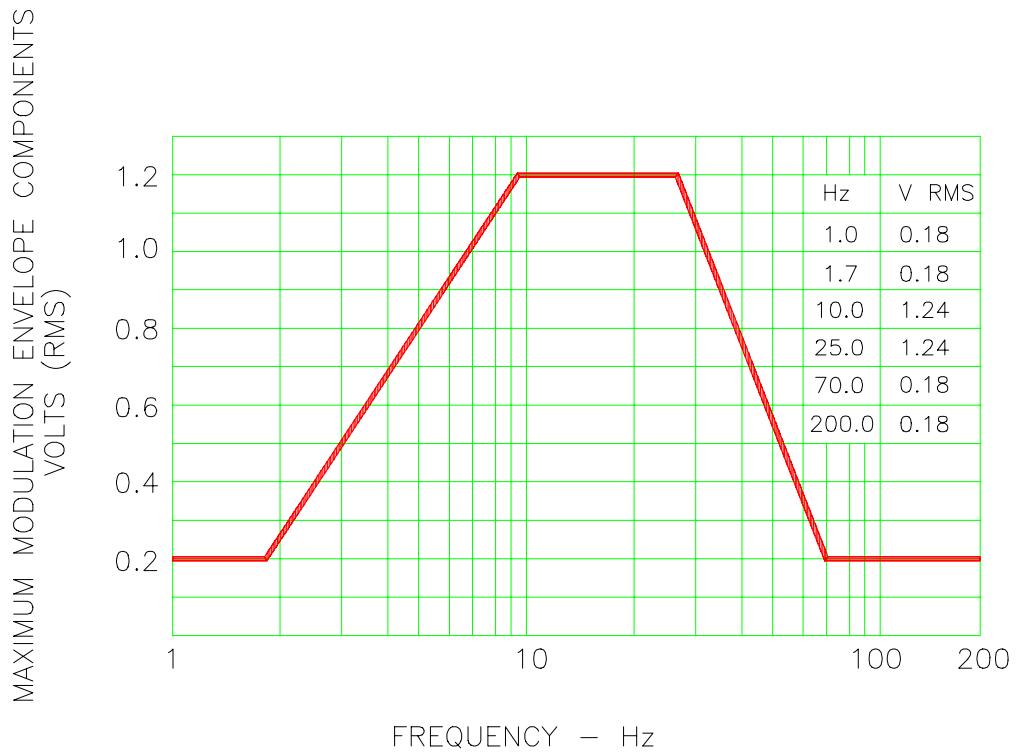

Figure 9-4: Voltage Modulation - Frequency characteristics

FREQUENCY MODULATION

This test requires a numeric value equal to the modulation rate in Hz. This value must be between 0.01 Hz and 100 Hz. The frequency modulation is calculated based on the modulation rate as defined in Figure 9-5. This test will last for a minimum of 2 minutes.

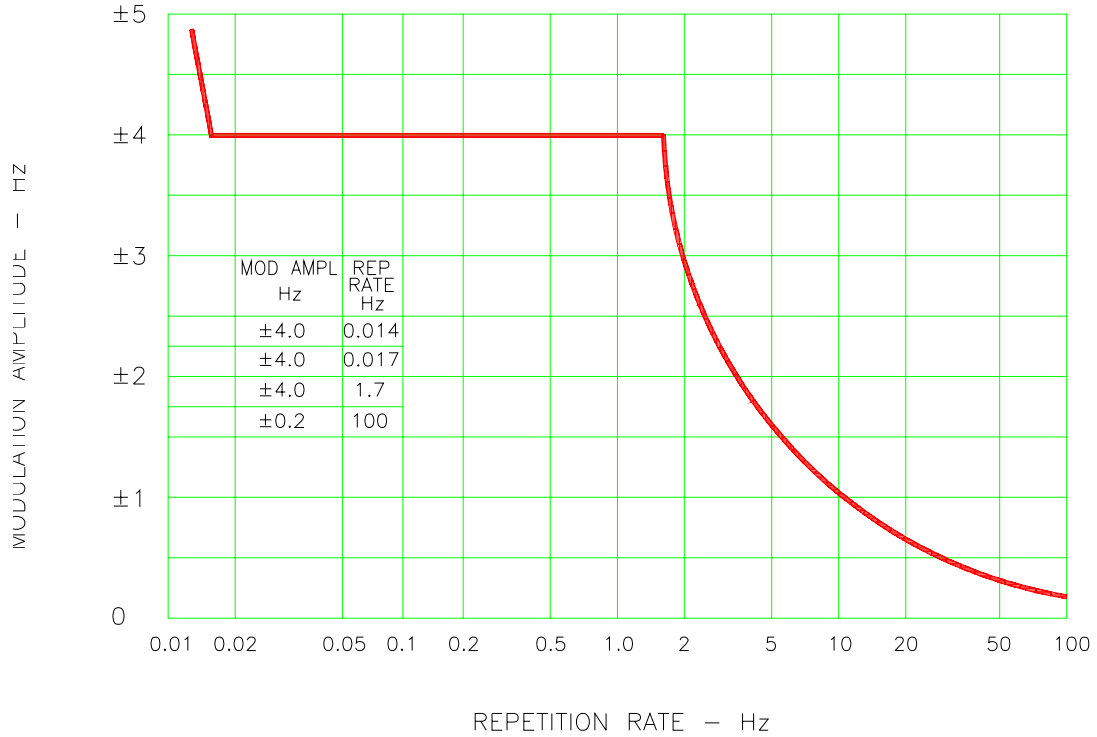
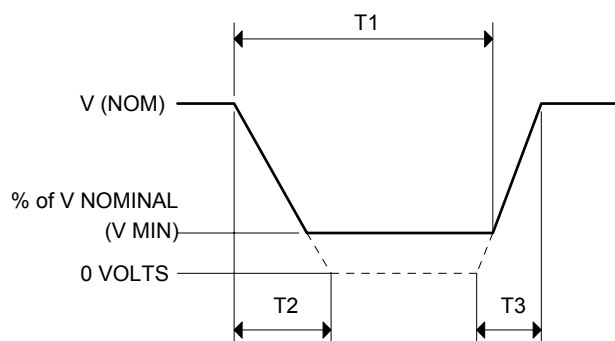

Figure 9-5: Frequency Modulation

POWER INTERRUPT

This test requires a numeric entry value equal to the test number. The tests are grouped as follows:

- Test numbers 1 through 15 are for all Standard and Groups. See Figure 9-6 for details of the tests.
- Test numbers 16 and 17 for all equipment that does not incorporate digital circuit. Test number 16 will drop the output to zero voltage for 50 ms. Test number 17 will drop the output to zero voltage for 200 ms. Test numbers 21 through 26 are applicable for Groups 2 and 3 only for EUROCAE standard and category A(NF) and A(WF) for RTCA2. Output frequency will be set to the F1 value for 1 second prior to the test. The output frequency will remain set to the F2 value when the test is completed. This will allow the user to apply sequence of power interrupts. See Figure 9-7 for detail of the tests.



DO160 Table 16-1: Test conditions for equipment with digital circuits.

- NOTES
- 1: Definitions:
 - T1 Power interrupt time
 - T2 Time it would take for the applied voltage to decay from V (nom) to zero volts.
 - T3 Time it would take for the applied voltage to rise from zero to V (nom) volts.
 - V MIN The minimum level (expressed as a percentage of V NOMINAL) to which the applied voltage is permitted to decay.
 - 2: Tolerance to T1, T2, T3 = ± 10%
 - 3: Test condition numbers 8 and 15 are for category Z, dc powered equipment only.

Applicable Category:	A				A, Z			Z	A, B, Z			A, Z			Z
	1**	2	3	4	5	6	7	8	9	10	11	12	13	14	15
Test Condition No.	1**	2	3	4	5	6	7	8	9	10	11	12	13	14	15
T1 (ms)	2**	10	25	50	75	100	200	1000	10	25	50	75	100	200	1000
T2 (ms)	<1	20*	20	20	20	20	20	20	50*	50*	50	50	50	50	50
T3 (ms)	<1	5	5	5	5	5	5	5	20	20	20	20	20	20	20
%V Nom. (V min)	0	50	15	10	5	0	0	0	80	50	0	15	5	0	0

* Voltage will not reach zero in this test condition.

** Equipment performance standards may require to repeat test n°1 with T1 varying from 5 to 200 ms by step defined in the test equipment performance standards (step typically comprised between 5 ms and 20 ms depending on equipment design).

Figure 9-6: Power Interrupt

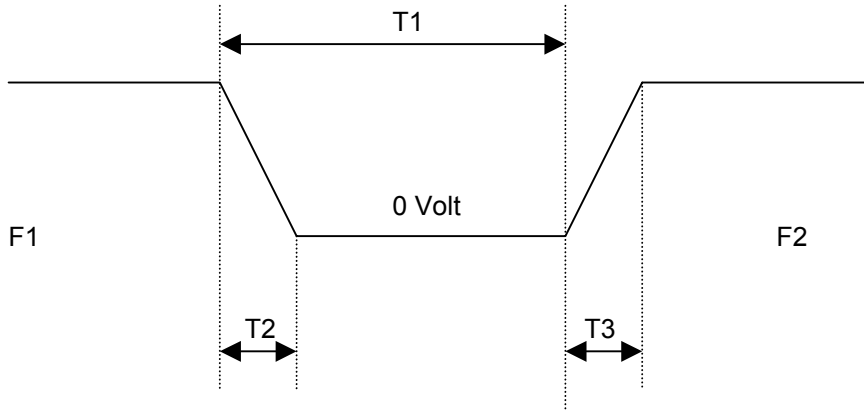

Test no.:	21	22	23	24	25	26
Standard:	I	II	III	IV	V	VI
T1 (ms)	50	50	100	100	200	200
F1 (Hz)	360	Fmax	360	Fmax	360	Fmax
F2 (Hz)	Fmax	360	Fmax	360	Fmax	360

Fmax = 650 Hz for Group2/A(NF)
 Fmax = 800 Hz for Group3/A(WF)
 T2 = 20 msec
 T3 = 5 msec

Figure 9-7: Power Interrupt for Group2/A(NF) and Group3/A(WF)

VOLTAGE SURGE

This test requires 160V output voltage. If the power source is set at the low voltage range, the high voltage range will be selected before the test starts. At the end of the test, the power source will be switched back to the low range automatically

Seq. No.	Voltage				Time
	RTCA	Group 1	Group 2	Group 3	ALL
1	115	115	115	115	5 Minute
2	160	160	160	170	30msec
3	115	115	115	115	5 Sec.
4	60	70	70	70	30msec
5	115	115	115	115	5 Sec.

Table 9-4: Normal VoltageSurge Sequence

The output voltage will follow the sequence in Table 9-4. The above sequence will repeat itself three times. Each repeat will start from sequence two. RTCA and Group 1 will run at 400 Hz. Group 2 and A(NF) will run at 360 Hz and 650 Hz. Group 3 and A(WF) will run at 360Hz and 800Hz. The frequency will return to the nominal setting when the test is completed. The ← key (backspace) will terminate the test at any time.

FREQUENCY TRANSIENTS (Group 1 and A(CF) only)

Seq. No	Frequency	Time
1	400	5 Minute
2	440	150msec
3	420	1.5sec
4	400	5Sec.
5	350	150msec
6	380	1.5sec
7	400	5Sec.

Table 9-5: Normal Frequency Transient Sequence

This test applies to Group1 and A(CF) only. The output voltage is set to Vnom (115 V) while the frequency is changed per the sequence listed in Table 9-5. The test will cycle 5 times starting from sequence 2. Steps 3 and 6 apply to A(CF) only.

FREQUENCY VARIATION (Group2 / A(NF) and Group3 / A(WF) only)

Seq. No	Initial Frequency		Slew rate	Final Frequency	
	Group2	Group3		Group2	Group3
1	360	360	100	650	800
2	650	800	100 or 200	360	360
3	360	360	Pause 5 sec	360	360

Table 9-6: Normal Frequency Variation Sequence

This test will apply to Group2/A(NF) and Group3/A(WF) only. . The output voltage is set to Vnom (115 V) while the frequency is set to 360Hz for 5 minutes. The frequency is slowed per the sequence listed in Table 9-6. The test will cycle 3 times. The frequency will return to nominal after the test is completed. Slew rates of 200Hz apply to RTCA2 only.

9.3.1.6 EMERGENCY TEST

From the DO160 MENU scroll to the EMERGENCY AC entry using the up and down cursor keys. Press the ENTER key to select the EMERGENCY screens. The screen will appear as shown in Figure 9-8.

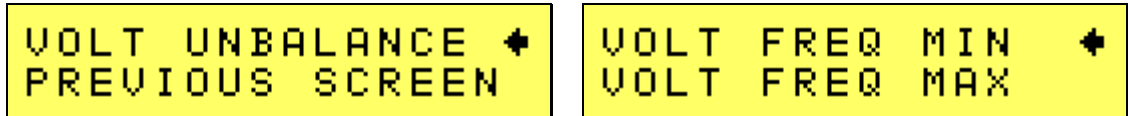

Figure 9-8: Emergency Screens

The EMERGENCY SCREEN has the following tests:

- 1 VOLT FREQ MIN
- 2 VOLT FREQ MAX
- 3 VOLT UNBALANCE

The above tests can be selected by scrolling to the highlighted selection using the up and down key and the ENTER key to start the selected test.

VOLT FREQ MIN

Standard/Group		RTCA	A(CF)	A(NF)	A(WF)
Voltage	1Φ	100	100	100	100
	3Φ	N/A	N/A	N/A	N/A
Frequency		360	360	360	360

Standard/Group		Group1	Group2	Group3
Voltage	1Φ	104	104	104
	3Φ	N/A	N/A	N/A
Frequency		360	360	360

Table 9-7: Emergency Voltage and Frequency Minimum

Standard/Group		RTCA	Group1	Group2	Group3
Voltage	1Φ	122	122	122	122
	3Φ	N/A	N/A	N/A	N/A
Frequency		440	440	650	800

Standard/Group		Group1	Group2	Group3
Voltage	1Φ	122	122	122
	3Φ	N/A	N/A	N/A
Frequency		440	650	800

Table 9-8: Emergency Voltage and Frequency Maximum

This test will set the voltage and frequency to a level defined by Table 9-7. The test will last for 30 minutes. The test will be repeated using the voltage from Table 9-8 and frequency from Table 9-7. The ← key (backspace) will terminate the test at any time.

VOLT FREQ MAX

This test will set the voltage and frequency to a level defined by Table 9-8. The test will last for 30 minutes. The test will be repeated using the voltage from Table 9-7 and frequency from Table 9-8. The ← key (backspace) will terminate the test at any time.

VOLT UNBALANCE

This test is not available on the MX15 Series since only a single phase output is available.

9.3.1.7 ABNORMAL TEST

From the DO160 MENU Scroll to the ABNORMAL AC entry using the up and down cursor keys. Press the ENTER key to select the ABNORMAL screens. The screen will appear as shown in Figure 9-9.

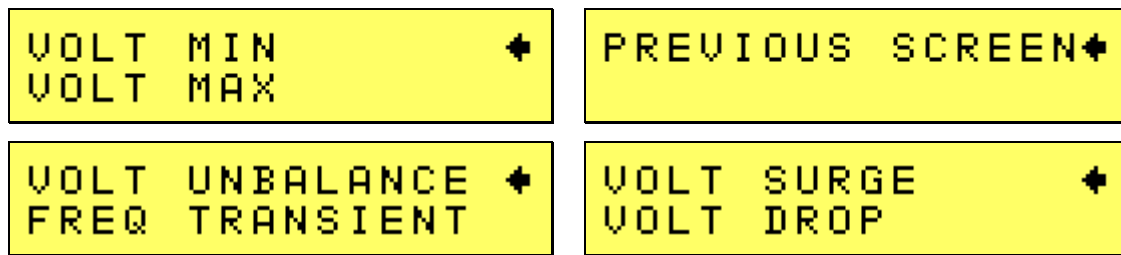

Figure 9-9: Abnormal Screen

The ABNORMAL SCREEN has the following tests:

- 1 VOLT MAX
- 2 VOLT MIN
- 3 VOLT UNBALNCE
- 4 VOLT SURG
- 5 VOLT DROP
- 6 FREQ TRANSIENTS

The above test can be selected by scrolling to the highlighted selection using the up and down key and the ENTER key to start the selected test.

VOLT MAX

Standard/Group		RTCA	Group1/A(CF)		Group2/A(NF)	Group3/A(WF)
Voltage	1	97	97	104/100	97	97
	3	N/A	N/A	N/A	N/A	N/A
Frequency		400	400	370	360	360

Table 9-9: Abnormal Voltage Minimum

Standard/Group		RTCA	Group1/ACF)		Group2/A(NF)	Group3/A(WF)
Voltage	1	134	134	122	134	134
	3	N/A	N/A	N/A	N/A	N/A
Frequency		400	400	430	650	800

Table 9-10: Abnormal Voltage Maximum

This test will set the voltage and frequency to levels defined by Table 9-9 for 5 minutes. The test will be repeated for Group1 and A(CF) only as indicated in Table 9-9 for voltage and Table 9-10 for frequency. All Groups will repeat the test using Table 9-10 for the voltage setting and Table 9-9 or Table 9-10 for the frequency setting. The ← key (backspace) will terminate the test at any time.

VOLT MIN

This test will set the voltage and frequency to levels defined by Table 9-10 for 5 minutes. The test will be repeated for Group1 only as indicated in Table 9-10. All Groups will repeat the test using Table 9-10 for the voltage setting and Table 9-9 for the frequency setting. The ← key (backspace) will terminate the test at any time.

VOLT UNBALANCE

This test is not available on the MX15 Series since only a single phase output is available.

VOLT UNDER

This test will drop the output voltage from 115 volts to 60 volts for 7 seconds.

VOLT SURGE

This test requires 180 volt output voltage. If the power source is set at the low voltage range, the high voltage range will be selected before the test starts. At the end of the test the AC source will be switched back to the low range.

The output voltage will surge to 180 volts for 100 ms. followed by drop to 148 volts for 1 sec before it returns to 115 volts. The ← key (backspace) will terminate the test at any time.

FREQUENCY TRANSIENTS (A(CF) only)

Test 1

Seq. No.	Volt/Frequency	Time
1	115/400	5 minutes
2	115/350	5 sec.
3	115/320	0.2 sec.
4	0/320	0.2 sec.
5	115V/400	10 sec.

Test 2

Seq. No.	Volt/Frequency	Time
1	115/400	5 minutes
2	115/480	0.2 sec.
3	115/440	5 sec.
4	0/440	0.2 sec.
5	115V/400	10 sec.

FREQUENCY TRANSIENTS (Group 1 only)

Seq. No.	Frequency	Time
1	400	5 minutes
2	480	5 sec.
3	400	10 sec.
4	320	5 sec.
5	400	10 sec.

Table 9-11: Abnormal Frequency Transient

This test will set the voltage at 115V and will remain at this voltage through out the test except for the A(CF) category. The test will cycle the frequency three times as shown in Table 9-11. Each repeat will start from sequence 2. Test1 and test2 for the A(CF) category are done in succession as a single test.

9.4 Option –704: MilStd704 Tests

The MIL704 option is made up of both firmware that resides in the power source and the MXGui Windows application program. The firmware covers revision D and E of the Mil-Std704 standard. The MXGui covers the remaining revisions A, B, C and F. This provides coverage of all available standard revisions.

The user interface for each implementation is different however. The revision D and E tests can be operated directly from the power source's front panel or through the supplied MXGui program. The revision A-C, F tests can only be operated through the supplied MXGui program. Thus, for rev A-C and F, a Windows PC and interface is required.

Section 9.4.1 covers operation of the firmware based revision D and E tests.

For information regarding the operation of the MIL-STD-704 revision A, B, C, and F tests with the MXGui, please refer to the Avionics Software Manual (CI part no. 4994-971 included on CDROM). Note that future updates of the MXGui may include overlapping coverage for revisions D and E in the software as the MXGui program is designed to support all revisions. For now, revisions D and E have no associated data files in the MXGui.

9.4.1 General

This user manual assumes that the user is familiar with the text of the relevant MIL-STD 704, test standard. No attempt is made to explain or elaborate on the actual test specification.

The MX15 supports two different implementations of the MIL-STD 704. This chapter covers the legacy implementation referred to on the menu screens as MIL704. This implementation pre-dates the release of the test protocol handbook that accompanied revision F of the standard.

Test Execution Considerations

Several of the MIL-STD 704 test steps take considerable time to execute. Tests in progress may be aborted by using the BACK button on the MX15 front panel.

9.4.2 Initial Setup

Nominal parameters for the AC Power source are as follows:

Output Voltage	115V L-N or 230V L-N
Output Frequency	360 Hz to 800 Hz for all revisions. 60 Hz for revision F only.

Nominal parameters for the DC Power source are as follows:

Output Voltage	28V or 270V L-N
----------------	-----------------

Note: *A setting outside these nominal values will disable the test and will prevent access to the 704 Menu screens or execution of any test step. To execute all tests for the 230V L-N, the power source must be capable of programming 360V RMS. This requires the -HV option. If this option is not installed, some tests will be skipped.*

9.4.3 Test Revision

The MIL-STD 704 option is capable of performing all sub-sections of MIL-STD 704 revision D, E or F. A selection is made available to specify the revision of standard to be applied to the EUT. The MIL704 option defaults to Revision E.

9.4.4 Tests Performed

9.4.4.1 STEADY STATE

AC Mode:

1. Steady State Voltage and Frequency test
2. Waveform Distortion test
3. Voltage Modulation test
4. Voltage Unbalance test
5. Phase Unbalance test
6. Frequency Modulation test
7. Voltage Modulation test
8. Transient Voltage low and high test
9. Transient Frequency low and high test

DC Mode:

1. Steady State Voltage test
2. Ripple test

9.4.4.2 EMERGENCY STATE

AC Mode:

1. Emergency Voltage minimum and maximum test
2. Emergency Frequency minimum and maximum test

DC Mode:

1. Emergency Voltage minimum and maximum test

9.4.4.3 ABNORMAL STATE

AC Mode:

1. Abnormal Voltage under
2. Abnormal Voltage over
3. Abnormal Frequency under
4. Abnormal Frequency under

DC Mode:

1. Abnormal Voltage under
2. Abnormal Voltage over

9.4.5 Front Panel Operation MIL704

To perform a test from the keyboard, from the MENU screen, select the APPLICATIONS screen. The APPLICATIONS screen will appear as shown in Figure 9-10.

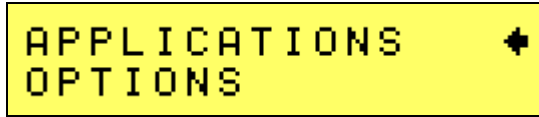

Figure 9-10: Applications Menu

Scroll to the MIL-STD-704 entry using the up and down cursor keys. Press the ENTER key to select the MIL704 main menu. One of the screens will appear as shown in Figure 9-11.

Note: The user has to turn on the Output relay before starting a test and set the steady state setup for the test. NOM FREQ must be set to match the desired steady state frequency. All MIL704 revisions will accept 400Hz as a nominal frequency. Revision F only will accept 60Hz and VFREQ.

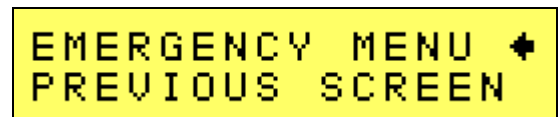
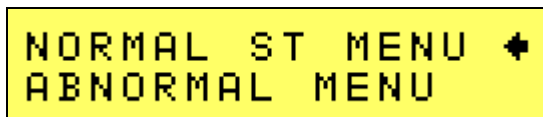
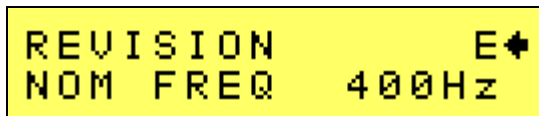

Figure 9-11: MIL704 Menu

9.4.5.1 Revision Selection

The default Revision is E. Revisions supported are D, E and F. The Revision can be changed from the front panel. Scroll to the REVISION entry using the up and down cursor keys (Figure 9-11). Use the shuttle to change the selection.

9.4.5.2 Nominal Frequency Selection

Three selections are available for the nominal frequency to be used:

- 400Hz, this selection is active in all revisions. Program frequency must be set to 400Hz.
- VFREQ, this selection is active for revision F only. Program frequency must be set between 360Hz and 800Hz to run the tests.
- 60Hz, this selection is active for revision F only. Program frequency must be set to 60Hz to run the tests.

Note that the programmed frequency of the AC source must be the same as the selected nominal test frequency selected in the 704 screen. If not, a Setting Conflict error will be generated when attempting to run a test. The programmed frequency can only be changed from the normal setup screen. Selecting the nominal test frequency in the 704 Application screen does not change the output frequency programmed.

9.4.6 Steady State AC Tests

Scroll to the NORMAL ST MENU entry using the up and down cursor keys. Press the ENTER key to select the STEADY STATE screens. The screen will appear as shown in Figure 9-12

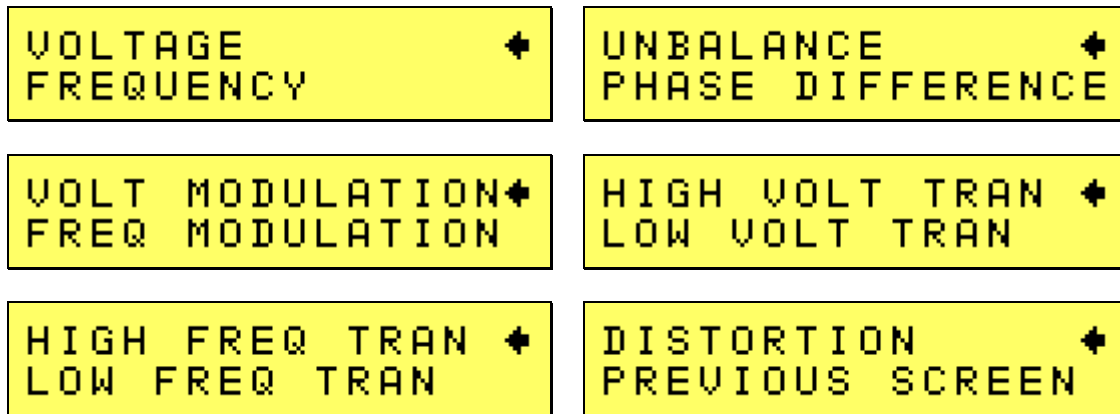

Figure 9-12: Steady State Menu

The MIL704 Steady state screens have the following tests:

1. VOLTAGE
2. FREQUENCY
3. VOLT UNBALANCE
4. PHASE DIFFERENCE
5. VOLT MODULATION
6. FREQ MODULATION
7. VOLT TRANSIENT
8. FREQ TRANSIENT
9. DISTORTION

The above tests can be selected by scrolling to the highlighted selection using the up and down cursor keys and the ENTER key to start the selected test.

VOLTAGE

This test will change the output voltage in the sequence shown in Table 9-12.

SEQUENCE	VOLTAGE		TIME
	400Hz/VFREQ	60Hz only	
1	108	110	1 minute
2	118	125	1 minute
3	115	115	1 minute

Table 9-12: Steady state voltage

The ← key (backspace) will terminate the test at any time.

FREQUENCY

This test will change the output frequency in the sequence shown in Table 9-13.

SEQUENCE	FREQUENCY	TIME
----------	-----------	------

	400Hz	VFREQ	60 Hz	
1	393	360	59	1 minute
2	407	800	61	1 minute
3	400	SSF	60	1 minute

Table 9-13: Steady state frequency

The ← key (backspace) will terminate the test at any time.

VOLT UNBALANCE

This test will change the output voltage for the selected phase only in the following sequence:

- 112V for 1 minute.
- 118V for 1 minute.
- 115V for 1 minute.

The test will be repeated on three phase systems to include all three phases if the coupling is set to all.

The ← key (backspace) will terminate the test at any time.

PHASE DIFFERENCE

This test applies to three phase systems only. The phase angle for the selected phase will change relative to phase A in the following sequence:

If phase B is selected:

- 236° for 1 minute.
- 244° for 1 minute.
- 240° for 1 minute.

If phase C is selected:

- 116° for 1 minute.
- 124° for 1 minute.
- 120° for 1 minute

VOLTAGE MODULATION

This test will vary the output voltage by $\pm 2.5V$ rms over a period of one second. The test will last for 2 minutes. The ← key (backspace) will terminate the test at any time.

FREQUENCY MODULATION

REVISION	D	E	F (400Hz /VFREQ)	F (60HZ)
MODULATION	$\pm 7Hz$	$\pm 4Hz$	$\pm 4Hz$	$\pm 0.5Hz$

Table 9-14: Frequency Modulation

This test will vary the output frequency as defined by Table 9-14 over a period of one minute. The test will last for 4 minutes. The ← key (backspace) will terminate the test at any time.

WAVEFORM DISTORTION

This test will generate a 5% THD voltage distortion on the output voltage waveform. Using a clipped sine wave causes the distortion. The test will last for 2 minutes. The ← key (backspace) will terminate the test at any time.

HIGH VOLTAGE TRANSIENT

This test will change the output voltage for the selected phase in the following sequence:

For 400 Hz and VFREQ:

- 180V for 10msec.
- Linearly reduced to 118V in 78msec.
- Stay at 118V for 87msec before returning to 115V.

For 60 Hz only:

- 170V for 1.67msec
- Linearly reduced to 130V in 14msec.
- Linearly reduced to 120V in 83.3msec.
- Stay at 120V for 75msec.

Note: Prior to the test, a voltage range change may take place if the power source is set for the low voltage range. This will cause the EUT to lose power momentarily. If this is not acceptable, the power source must be left in high range at all times.

After this sequence, a 5 second delay will be inserted at the nominal test voltage. The ← key (backspace) will terminate the test at any time.

LOW VOLTAGE TRANSIENT

This test will change the output voltage for the selected phase only in the following sequence:

For 400 Hz and VFREQ:

- 80V for 10msec.
- Linearly increase to 108V in 70msec.
- Stay at 108V for 95msec before returning to 115V.

For 60Hz only:

- 0V for 1.67msec.
- Linearly increase to 70V in 14msec.
- Linearly increase to 105V in 83.3msec
- Stay at 105V for 75msec.

After this sequence, a 5 second delay will be inserted at the nominal test voltage. The ← key (backspace) will terminate the test at any time.

HIGH FREQUENCY TRANSIENT

This test will change the output frequency in the following sequence:

For 400Hz and VFREQ:

- 425Hz for 1 sec.
- 420Hz for 4 sec.

- 410Hz for 5 sec.
- 407Hz for 4 sec.

For 60Hz only:

- 61Hz for 0.5 sec.
- 60.5Hz for 0.5 sec.

After this sequence, a 5 second delay will be inserted at the nominal test frequency. The ← key (backspace) will terminate the test at any time.

LOW FREQUENCY TRANSIENT

This test will change the output frequency in the following sequence:

For 400Hz and VFREQ:

- 375Hz for 1 sec.
- 380Hz for 4 sec.
- 390Hz for 5 sec.
- 393Hz for 4 sec.

For 60Hz only:

- 59Hz for 0.5 sec.
- 59.5Hz for 0.5 sec.

After this sequence, a 5 second delay will be inserted at the nominal test frequency. The ← key (backspace) will terminate the test at any time.

9.4.7 EMERGENCY AC TESTS

From the MIL704 main menu (Figure 9-11) scroll to the EMERGENCY entry using the up and down cursor keys. Press the ENTER key to select the EMERGENCY screens. The screen will appear as shown in Figure 9-13.

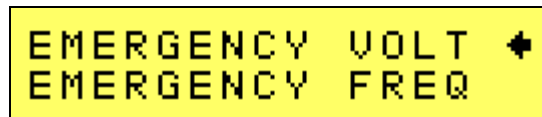

Figure 9-13: Emergency Menu

The EMERGENCY SCREEN has the following tests:

- 1 VOLTAGE
- 2 FREQUENCY

The above tests can be selected by scrolling to the highlighted selection using the up and down key and the ENTER key to start the selected test.

Note: *These tests are only required for revision D. See steady state voltage and frequency tests for all other revisions.*

VOLTAGE

This test will change the output voltage in the following sequence:

- 104V for 1 minute.
- 122V for 1 minute.
- 115V for 1 minute.

The ← key (backspace) will terminate the test at any time.

FREQUENCY

This test will change the output frequency in the following sequence:

- 360Hz for 1 minute.
- 440Hz for 1 minute.
- 400Hz for 1 minute.

The ← key (backspace) will terminate the test at any time.

9.4.7.1 ABNORMAL TEST

From the MIL704 main menu (Figure 9-11) scroll to the ABNORMAL AC entry using the up and down cursor keys. Press the ENTER key to select the ABNORMAL screens. The screen will appear as shown in Figure 9-14.

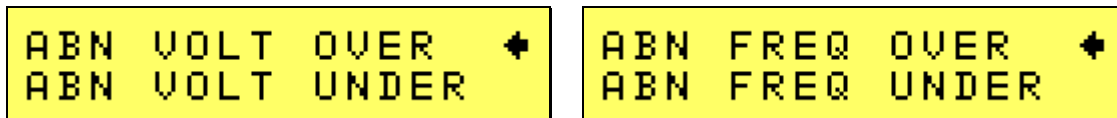

Figure 9-14: Abnormal Screens

The ABNORMAL SCREEN has the following tests:

1. OVER VOLTAGE
2. UNDER VOLTAGE
3. OVER FREQUENCY
4. UNDER FREQUENCY

The above test can be selected by scrolling to the highlighted selection using the up and down key and the ENTER key to start the selected test.

OVER VOLTAGE

This test will change the output voltage for the selected phase in the following sequence:

For 400Hz and VFREQ:

- 180V for 50msec.
- The voltage gradually decays with time to 125 volt by the following equation:

$$V = 124.6 + 2.77/t. \text{ For } 0.05 \leq t \leq 6.925$$
- Stay at 125V for 93 seconds before returning to 115V.

For 60Hz only:

- 180V for 3.34msec
- The Voltage gradually decays with time to 122 volt by the following equation:

$$V = 121.7 + 0.583/t. \text{ For } 0.00334 \leq t \leq 1.947$$

- Stay at 122V for 8 seconds before returning to 115V.

Note: Prior to the test, a voltage range change may take place if the power source is set for the low voltage range. This will cause the EUT to loose power momentarily. If this is not acceptable, the power source must be left in high range at all times.

The ← key (backspace) will terminate the test at any time.

UNDER VOLTAGE

This test will change the output voltage for the selected phase in the following sequence:

For 400Hz and VFREQ:

- 0V for 7 seconds.
- 100V for 93 seconds.

For 60Hz only

- 0V for 2 seconds.
- 100V for 8 seconds.

The ← key (backspace) will terminate the test at any time.

OVER FREQUENCY

This test will change the output frequency in the sequence shown in Table 9-15 before returning to the steady state frequency.

The ← key (backspace) will terminate the test at any time.

Revision	D		E		F		F 60Hz only	
	FREQ	Time	FREQ	Time	FREQ	TIME	FREQ	TIME
Seq1	480Hz	5sec.	480Hz	5sec.	480Hz	5sec	61Hz	7sec
Seq2	420Hz	5sec	420Hz	9sec	420Hz	5sec	60.5Hz	8sec

Table 9-15: Abnormal Over Frequency

After this sequence, a 5 second delay will be inserted at the nominal test frequency. The ← key (backspace) will terminate the test at any time.

UNDER FREQUENCY

This test will change the output frequency in the sequence shown in Table 9-16 before returning to steady state frequency.

The ← key (backspace) will terminate the test at any time.

Revision	D		E		F		F 60Hz only	
	FREQ	Time	FREQ	Time	FREQ	TIME	FREQ	TIME
Seq1	0	5sec.	0Hz	7sec.	0Hz	7sec	0Hz	7sec
Seq2	375Hz	5sec	380Hz	7sec	380Hz	3sec	59.5Hz	8sec

Table 9-16: Abnormal Under Frequency

After this sequence, a 5 second delay will be inserted at the nominal test frequency. The ← key (backspace) will terminate the test at any time.

9.4.8 DC Tests

If the output voltage is set for 28V DC or 270V DC the MIL704 DC Main selection screen will appear as seen in Figure 9-15.

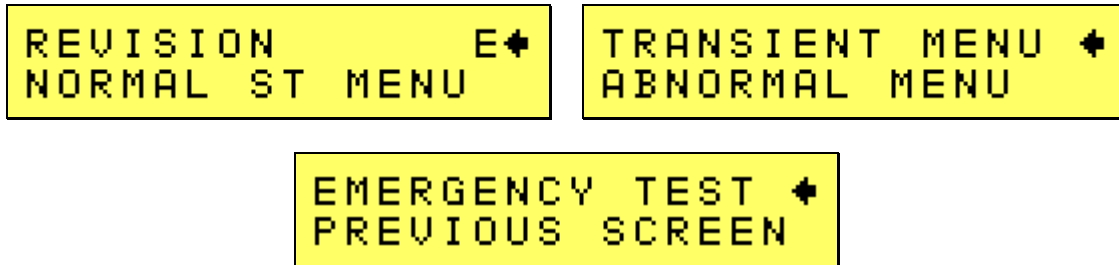

Figure 9-15: MIL704 DC Menu

9.4.8.1 Steady State Test

Scroll to the NORMAL ST MENU entry using the up and down cursor keys. Press the ENTER key to select the STEADY STATE screen. The screen will appear as shown Figure 9-16.

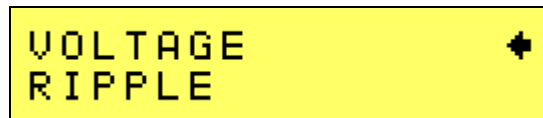

Figure 9-16: Steady State DC

The MIL704 STEADY STATE screen has the following tests:

- 1 VOLTAGE
- 2 RIPPLE

The above tests can be selected by scrolling to the highlighted selection using the up and down key and the ENTER key to start the selected test.

VOLTAGE

This test will change the output voltage for the selected phase in the following sequence:

1. 28V system:
 - 22V for 1 minute.
 - 29V for 1 minute.
 - 28V for 1 minute.
2. 270V system:
 - 250V for 1 minute.
 - 280V for 1 minute.
 - 270V for 1 minute.

The ← key (backspace) will terminate the test at any time.

DC RIPPLE

This test will impose a 400Hz frequency component to the output voltage. The test will last for 2 minutes. The level of the ripple is as follows:

1. 28V system:
±1.5V.
2. 270V system:
±6.0V.

The ← key (backspace) will terminate the test at any time.

9.4.8.2 Transient Test

From the MIL704 DC MENU scroll to the TRANSIENT DC entry using the up and down cursor keys. Press the ENTER key to select the TRANSIENT screen. The screen will appear as shown in Figure 9-17.

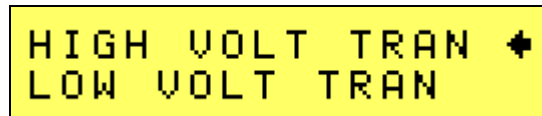

Figure 9-17: Transient Menu

The Transient Test has the following tests:

- 1 HIGH VOLTAGE
- 2 LOW VOLTAGE

HIGH VOLTAGE

This test will change the output voltage for the selected phase in the following sequence:

1. 28V System
 - 50V for 12.5 msec.
 - Linearly reduce to 29V in 70msec.
 - Stay at 29V for 92.5msec before returning to 28V.
2. 270V System
 - 330V for 20 msec.
 - Linearly reduce to 280V in 20msec.
 - Stay at 280V for 135msec before returning to 270V.

Prior to the test, a range change may take place if the power source is set for the low voltage range.

The ← key (backspace) will terminate the test at any time.

Note: A range change will result in momentary loss of power to the EUT. If this is not acceptable, the power source must be left in high range at all times.

LOW VOLTAGE

This test will change the output voltage for the selected phase in the following sequence:

1. 28V System
 - 18V for 15 msec.

- Linearly increase to 22V in 85msec.
- Stay at 22V for 75msec before returning to 28V.

2. 270V System

- 200V for 10 msec.
- Linearly increase to 250V in 30msec.
- Stay at 250V for 135msec before returning to 270V.

The ← key (backspace) will terminate the test at any time.

9.4.8.3 Abnormal Test

From the MIL704 DC MENU scroll to the ABNORMAL DC entry using the up and down cursor keys. Press the ENTER key to select the ABNORMAL screen. The screen will appear as shown in Figure 9-18.

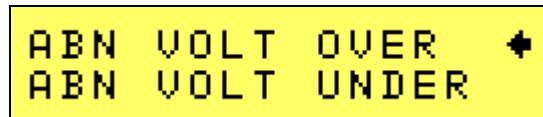

Figure 9-18: Abnormal Test Screen

The Abnormal Test has the following tests:

- 1 OVER VOLTAGE
- 2 UNDER VOLTAGE

The above tests can be selected by scrolling to the highlighted selection using the up and down cursor keys and the ENTER key to start the selected test.

OVER VOLTAGE

This test will change the output voltage for the selected phase in the following sequence:

1. 28V system:
 - 50V for 50msec.
 - The voltage gradually decays with time to 31.5 volts by the following equation:

$$V = 31.38 + 0.93/t \text{ for } 0.05 \leq t \leq 7.758$$
 - Stay at 31.5V for 92.242 seconds before returning to 28V.
2. 270V system:
 - 350V for 50msec.
 - The voltage gradually decays with time to 290 volts by the following equation:

$$V = 289.6 + 3.02/t \text{ for } 0.05 \leq t \leq 7.55$$
 - Stay at 290V for 92.45 seconds before returning to 270V.

Prior to the test, a range change may take place if the power source is set at the low voltage range. Note: See Section 9.4.6 under HIGH VOLTAGE TRANSIENT.

The ← key (backspace) will terminate the test at any time.

Note: A range change will result in momentary loss of power to the EUT. If this is not acceptable, the power source must be left in high range at all times.

UNDER VOLTAGE

This test will change the output voltage for the selected phase in the following sequence:

1. 28V system:
 - 0V for 7sec.
 - 20V for 93sec.
2. 270V system:
 - 0V for 7sec.
 - 240V for 93sec.

The ← key (backspace) will terminate the test at any time.

9.4.8.4 Emergency Test

From the MIL704 DC MENU scroll to the EMERGENCY DC entry using the up and down cursor keys (Figure 9-19). Press the ENTER key to start the EMERGENCY TEST.

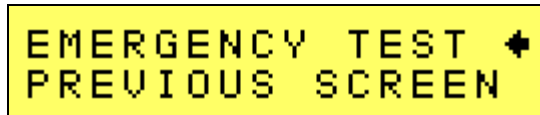

Figure 9-19: Emergency Test

VOLTAGE

This test will change the output voltage for the selected phase in the following sequence:

1. 28V system:
 - 18V for 1 minute.
 - 29V for 1 minute.
 - 28V for 1 minute.
2. 270V system:
 - 250V for 1 minute.
 - 280V for 1 minute.
 - 270V for 1 minute.

The ← key (backspace) will terminate the test at any time.

9.5 Option –ABD: Airbus ABD0100.1.8 Test

For information regarding the operation of the ABD0100.1.8 tests with the MXGui, please refer to the Avionics Software Manual (CI part no. 4994-971 included on CDROM).

9.6 Option –787: Boeing B787-0147 Test

For information regarding the operation of the Boeing B787-0147 tests with the MXGui, please refer to the Avionics Software Manual (CI part no. 4994-971 included on CDROM).

9.7 Option –WHM: Watt Hour Measurement

9.7.1 General

This section describes the WHM option available for the MX Series Power Source.

9.7.2 Specification

All specifications are the same as the standard MX Power Source specifications in addition to the following specifications:

Watt-hour

0-6.000KW	0.2%FS +0.1%R	<100 Hz
	0.5%FS +0.1%R	100-819 Hz
>6.000KW	Times three of the above specification	

9.7.3 Local Operation

- From the APPLICATIONS menu screen, use the up and down key to position the cursor to the WHM field. Press the Enter Key.
- The WATT-HOURS METER screen shown in Figure 9-20 has the following fields:

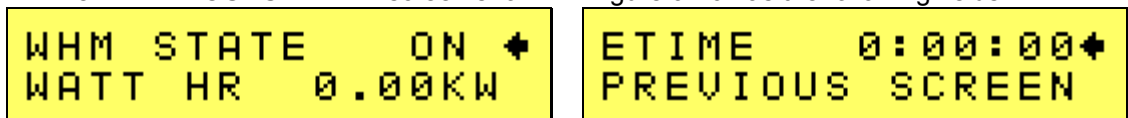

Figure 9-20: Watt-Hour Meter Screen

- WHM STATE: This field will activate the watt-hour measurements. Moving the shuttle clockwise when the field is highlighted will activate the watt-hour function and the field will change to ON as shown in Figure 9-20.
- ETIME: This field will accumulate the time in hours, minutes and seconds.
- WATT HR: This field will accumulate the watt-hour in KWH.



Figure 9-21: WH-Meter Screen with Function Active

Note: Changing from ON to OFF will stop the measurement and will maintain the last data record for the watt-hour meter. To restart the measurements, the field is toggled to the ON position from the OFF position and the previous data will be reset to zeros.

10 Error Messages

Any errors that occur during operation from either the front panel or the remote control interface will result in error messages. Error messages are displayed in the upper left hand corner of the LCD display. They are also stored in the error message queue from which they can be queried using the SYST:ERR? Query. The error queue has a finite depth. If more error messages are generated than can be held in the queue, a queue overflow message will be put in the last queue location. To empty the queue, use the error query until the No Error result is received.

Errors appearing on the LCD will generally remain visible until the user moves to another screen. If multiple error messages are generated in succession, only the last message will be visible as there is only space for one error message on the LCD display.

The same area of the display is also used to display status messages. While error messages always have a negative error number, status messages have a positive number.

The table below displays a list of possible error and status messages along with their possible cause and remedy.

Number	Message String	Cause	Remedy
0	"No error"	No errors in queue	
-100	"Command error"	Unable to complete requested operation	Unit may be in a mode inconsistent with request.
-102	"Syntax error"	Command syntax incorrect.	Misspelled or unsupported command
-103	"Invalid separator"	SCPI separator not recognized	See SCPI section of programming manual.
-104	"Data type error"	Data type invalid.	Check command for supported data types
-108	"Parameter not allowed"	One or more additional parameters were received.	Check programming manual for correct number of parameters
-109	"Missing parameter"	Too few parameters received for requested operation	Check programming manual for correct number of parameters
-110	"Command header error"	Command header incorrect	Check syntax of command.
-111	"header separator error"	Invalid command separator used.	Use semi-colon to separate command headers
-112	"Program mnemonic too long"	Syntax error	Check programming manual for correct command syntax
-113	"Undefined header"	Command not recognized error	Check programming manual for correct command syntax
-120	"Numeric data error"	Data received is not a number	Check programming manual for correct command syntax
-121	"Invalid character in number"	Number received contains non-numeric character(s)	Check programming manual for correct command syntax
-123	"Exponent too large"	Exponent in number exceeds limits	Check programming manual for correct parameter range
-128	"Numeric data not allowed"	Number received when number is not allowed.	Check programming manual for correct command syntax
-168	"Block data not allowed"	Block data was sent.	Check programming manual for correct command syntax
-200	"Execution error"	Command could not be	Command may be inconsistent

Number	Message String	Cause	Remedy
		executed	with mode of operation such as programming frequency when in DC mode.
-201	"Invalid while in local"	Command issued but unit is not in remote state	Put instrument in remote state before issuing GPIB commands.
-203	"Command protected"	Command is locked out	Some commands are supported by the unit but are locked out for protection of settings and are not user accessible.
-210	"Trigger error"	Problem with trigger system.	Unit could not generate trigger for transient execution or measurement.
-211	"Trigger ignored"	Trigger request has been ignored.	Trigger setup incorrect or unit was not armed when trigger was received. Check transient system or measurement trigger system settings.
-213	"Init ignored"	Initialization request has been ignored	Unit was told to go to armed state but was unable to do so. Could be caused by incorrect transient system or measurement acquisition setup.
-220	"Parameter error"	Parameter not allowed.	Incorrect parameter or parameter value. Check programming manual for allowable parameters
-221	"Setting conflict"	Requested setting conflicts with other setting in effect.	Check other settings. E.g. trying to program a DC offset while in AC mode
-222	"Data out of range"	Parameter data outside of allowable range.	Check programming manual for allowable parameter values
-223	"Too much data"	More data received than expected	Check programming manual for number of parameters or data block size
-224	"Illegal parameter value"	Parameter value is not supported	Check programming manual for correct parameters
-226	"Lists not same length"	One or more transient lists programmed has different length.	All lists must be of same length or transient cannot be compiled and executed.
-241	"Hardware missing"	N/A	N/A
-254	"Media full"	No storage space left to save settings or data.	Delete other settings or data to make room.
-255	"Directory full"	Too many waveform directory entries	Delete one or more waveforms from waveform memory to make room.
-256	"File name not found"	Waveform requested not in directory	Check waveform directory for waveform names present.
-257	"File name error"	Incorrect filename	Too many or non ASCII characters used in waveform file definition.
-283	"Illegal variable name"	Variable name illegal.	Use ASCII characters only
-300	"Device specific error"	Hardware related error	Check hardware for proper

Number	Message String	Cause	Remedy
			operation.
-311	"Memory error"	Waveform memory checksum error.	May be the result of incomplete user-defined waveform download. Check interface and try downloading waveform again. Successful download may clear this error condition. Alternatively, use TRAC:DEL:ALL command to clear waveform memory.
-314	"Save/recall memory lost"	User setup register contents lost	Store setup in same register again.
-315	"Configuration memory lost"	Hardware configuration settings lost.	Contact CI service department at support@calinst.com to obtain instructions on restoring configuration data.
-330	"Self-test failed"	Internal error	Contact CI service department at support@calinst.com
-350	"Queue overflow"	Message queue full.	Too many messages. Read status using SYST:ERR query until 0, "No Error" is received indicating queue empty.
-400	"Query error"	Unable to complete query.	Check programming manual for correct query format and parameters
-410	"Query INTERRUPTED"	Query issued but response not read.	Check application program for correct flow. Response must be read after each query to avoid this error.
-420	"Query UNTERMINATED"	Query incomplete.	Check for terminator after query command.
-430	"Query DEADLOCKED"	Query cannot be completed	Check application program for multiple queries
-440	"Query UNTERMINATED"	Query incomplete.	Check for terminator after query command.
1	"Output volt fault"	Output voltage does not match programmed value.	Load exceeds current limit and unit is in Constant Voltage (CV) mode of operation. Reduce load or increase CL setting. Output voltage is driven above programmed voltage by external influence (Load, voltage kickback, etc.)
2	"Current limit fault"	Current limit exceeded.	Load exceeds current limit and unit is in Constant Voltage (CV) mode of operation. Reduce load or increase CL setting
3	"Temperature fault"	Temperature of heat sink too high.	Reduce load. Ensure proper airflow and exhaust clearance. Check fan(s) for operation.
4	"External sync. error"	Could not sync to external sync signal.	External sync signal missing, disconnected or out of range.
5	"Initial memory lost"	Power on settings could	Save power on settings again to

Number	Message String	Cause	Remedy
		not be recalled.	overwrite old content.
6	"Limit memory lost"	Hardware configuration settings lost.	Contact CI service department at support@calinst.com to obtain instructions on restoring configuration data.
7	"System memory lost"	Memory corrupted.	Recycle power.
8	"Calibration memory lost"	Calibration data lost.	Contact CI service department at support@calinst.com to obtain instructions on restoring calibration data or recalibrate unit.
9	"Start angle must be first sequence"	Start phase angle in wrong place..	Start phase angles can only be programmed at the start of a transient list. Once a transient is in progress, phase angle cannot be changed.
10	"Illegal for DC"	Operation not possible in DC mode.	Switch to AC or AC+DC mode.
11	"Duplicate sequence"	Transient list sequence number already used.	User new or available sequence number instead.
12	"Too many sequence"	Number of transient list steps exceeds maximum.	Reduce the number of steps in the transient list. (Max = 32 for Series I or 100 for Series II).
13	"Missing list parameter"	One or more transient list parameters missing.	Check programmed lists.
14	"Voltage peak error "	Peak voltage exceeds internal bus voltage	This error may occur when selecting user defined wave shapes with higher crest factors. Reduce programmed RMS value.
15	"Slew time exceed dwell"	Time needed to slew to final value is less than dwell time.	Check dwell times in transient list settings. Increase dwell time or change slew rate for affected parameter.
16	"Illegal during transient"	Operation requested not available while transient is running.	Wait till transient execution is completed or abort transient execution first.
17	"Output relay must be closed"	Operation not possible with open relay	Close relay before attempting operation. E.g. transient execution requires output relay to be closed.
18	"Trans. duration less than 1msec"	Dwell time below minimum or 1 msec	Increase dwell time to at least 1 msec.
19	"Clock and sync must be internal"	Operation not possible with external clock	Switch to internal sync. (Default)
20	"Input buffer full"	Too much data received.	Break up data in smaller blocks.
21	"EOS Fault"	Hardware error reported by EOS option	Cycle power on EOS to reset error. If error persists, contact CI service at support@calinst.com for repair.
22	"Waveform harmonics	Harmonic contents of user	Reduce harmonic content or

Number	Message String	Cause	Remedy
	limit"	defined wave shape are too high and could damage amplifier.	reduce fundamental frequency programmed.
23	"ALC or Impedance must be off"	Conflict between ALC and programmable impedance mode.	Turn off ALC to use programmable impedance. Turn off programmable impedance to use ALC.

Table 10-1: Error Messages

Index

7

704..... 155

A

AC

input..... 34

Acoustic..... 20, 28

address

GPIB..... 86

IEEE..... 86

Airbus

DO160..... 145

ALC

state..... 78

Arbitrary waveforms

Frequency response restrictions..... 99

arrow keys..... 67

B

Back key..... 68

baud rate..... 86

blinking

parameter entry..... 67

bus address

setting..... 86

C

calibration

password..... 122

Calibration password..... 89

CE[®] mark..... 20

circuit breaker..... 65

Clock and Lock

Initialization..... 58

Clock and Lock mode..... 57

Clock and Lock Mode

Configuration..... 57

clock mode..... 77

constant current..... 115

Constant Power..... 28

Construction

internal..... 19

Controllers

programable..... 21

Cooling..... 19

current / voltage sensor..... 115

current limit..... 111

custom waveforms..... 97

creating..... 97

deleting..... 98

downloading..... 98

D

DC offset

-HV range..... 140

Dimensions..... 19

DIP switch..... 55

Distorted output..... 130

DO160

Airbus..... 145

Option..... 141

DVM..... 115

E

Efficiency..... 11

Emissions..... 20

Enter key..... 69

error messages..... 170

-ES..... 22

External Sync

Clock/Lock..... 58

F

Finish

paint..... 19

Frequency Range..... 13, 25

front panel..... 65

lock..... 68

Front panel

Lock..... 66

Function Strobe..... 17

Functional Test..... 60

Fuse check..... 131

Fuses

Input..... 110

H

-HF..... 22

Hold-Up Time..... 11

-HV

restrictions..... 140

I

IEEE-488..... 18

Immunity..... 20

Inrush Current..... 11

installation..... 34

Introduction..... 10

Isolation Voltage..... 11

J

junction box..... 63

K		Output Status	17
keypad	68	over current	115
function	68	Overcurrent	19
Keys		overload	66
ES Option	22	Overtemperature	19
knob	67	Overvoltage	19
L		P	
LAN	18	Parallel	21
connector	54	password	
MAC Address	54	calibration	122
LCD		Password	
viewing angle	89	Calibration	89
LCD display	69	phase angle	75
LED	115, 129	Power Factor	11
LED indicators	129	power on screens	70
-LF	22	power-down	56
Line Current:	11	power-on setting	85
Line Frequency	11	Programming manual	10
Line VA:	11	pulse transient	105
list transient	106	R	
LOCAL key	68	Regulation	78
Low Voltage PS	115	Relay	
M		output	21
MAC Address	54	Remote control	66
maintenance	129	Remote Inhibit	62
Material		replacement parts	137
chassis	19	RJ45	
-MB	22	connector	54
-MB Option	22	RS232	
Meas key	68	Cable	51
Menu key	68	Connector	51
MIL-STD 704		RS232 connector	51
Option	155	RS232C	18
Modulator	111	S	
Multi-cabinet	55	Safety	20
N		sense	129
Noise	12	wiring	40
O		Set key	68
Offset Voltage		SET mode	67
DC	12	setting	
Options		baud rate	86
-160	141	GPIB address	86
-704	155	Shock	20
oscillator	111	Short Circuit	
output		current	19
frequency	75	shutdown	56
noise spectrum	29	shuttle	67
on/off key	68	SET mode	67
voltage	75	Shuttle	
Output Coupling	12, 23	IMMEDIATE mode	67
output relay	68	status	66
		step transient	104
		system interconnect	110

System Interface	115	Turn on.....	56
T		U	
temperature		UP key	69
over	66	USB	18
Temperature		connector	53
operating,storage.....	20	V	
Three phase	110	Vibration	20
top cover		viewing angle	21
removal	131	adjustment.....	89
transient		voltage drop	
execution	109	cables	38, 41
Transient list		voltage rating	33
execution	82	W	
transients		Weight.....	19
list.....	106	Wire Sizes.....	38, 41
pulse	105	wiring	
step	104	input.....	34
switching waveforms	108	X	
Transients		-XV range	
Front panel data entry	84	restrictions	140
Input.....	19		
Trigger			
input BNC	17		
output BNC	17		
troubleshooting.....	129		